

Service Manual

PM8004 /K1SG/U1B
PM-KI-PEARL-LITE /N1SG/N1B
△ N2SG/N2B
Integrated Amplifier

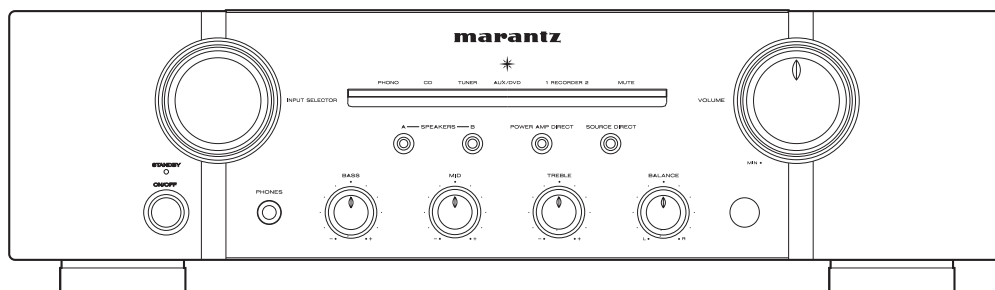

PM8004
PM-KI-PEARL-LITE

• For purposes of improvement, specifications and design are subject to change without notice.

• Please use this service manual with referring to the operating instructions without fail.

• Some illustrations using in this service manual are slightly different from the actual set.

marantz®

PM8004
PM-KI-PEARL-LITE

Ver. 2

Please refer to the
MODIFICATION NOTICE.

MARANTZ DESIGN AND SERVICE

Using superior design and selected high grade components, **MARANTZ** company has created the ultimate in stereo sound. Only original **MARANTZ** parts can insure that your **MARANTZ** product will continue to perform to the specifications for which it is famous.

Parts for your **MARANTZ** equipment are generally available to our National Marantz Subsidiary or Agent.

ORDERING PARTS :

Parts can be ordered either by mail or by Fax.. In both cases, the correct part number has to be specified.

The following information must be supplied to eliminate delays in processing your order :

1. Complete address
2. Complete part numbers and quantities required
3. Description of parts
4. Model number for which part is required
5. Way of shipment
6. Signature : any order form or Fax. must be signed, otherwise such part order will be considered as null and void.

USA

MARANTZ AMERICA, INC
100 CORPORATE DRIVE
MAHWAH, NEW JERSEY 07430
USA

EUROPE / TRADING

D&M EUROPE B. V.
P. O. BOX 8744, BUILDING SILVERPOINT
BEEMDSTRAAT 11, 5653 MA EINDHOVEN
THE NETHERLANDS
PHONE : +31 40 2507844
FAX : +31 40 2507860

CANADA

D&M Canada Inc.
5 505 APPLE CREEK BLVD.
MARKHAM, ONTARIO L3R 5B1
CANADA
PHONE : 905 415 9292
FAX : 905 475 4159

JAPAN

D&M Holdings Inc.
D&M BUILDING, 2 1 NISSHIN CHO,
KAWASAKI KU, KAWASAKI SHI,
KANAGAWA, 210 8569 JAPAN

株式会社 ディーアンドエムホールディングス

本 社 〒210-8569
神奈川県川崎市川崎区日進町2-1 D&Mビル

KOREA

D&M SALES AND MARKETING KOREA LTD.
2F, YEON BLDG.,
88 5, BANPO DONG, SEOCHO GU,
SEOUL KOREA
PHONE : +82 2 715 9041
FAX : +82 2 715 9040

CHINA

D&M SALES AND MARKETING SHANGHAI LTD.
ROOM.808 SHANGHAI AIRPORT CITY TERMINAL
NO.1600 NANJING (WEST) ROAD, SHANGHAI,
CHINA. 200040
TEL : 021 6248 5151
FAX : 021 6248 4434

NOTE ON SAFETY :

Symbol ⚠ Fire or electrical shock hazard. Only original parts should be used to replaced any part marked with symbol ⚠.

Any other component substitution (other than original type), may increase risk of fire or electrical shock hazard.

安全上の注意 :

⚠がついている部品は、安全上重要な部品です。必ず指定されている部品番号の部品を使用して下さい。

SHOCK, FIRE HAZARD SERVICE TEST :

CAUTION : After servicing this appliance and prior to returning to customer, measure the resistance between either primary AC cord connector pins (with unit NOT connected to AC mains and its Power switch ON), and the face or Front Panel of product and controls and chassis bottom.

Any resistance measurement less than 1 Megohms should cause unit to be repaired or corrected before AC power is applied, and verified before it is return to the user/customer.

Ref. UL Standard No. 60065.

In case of difficulties, do not hesitate to contact the Technical Department at above mentioned address.

091105DM/DG

SAFETY PRECAUTIONS

The following check should be performed for the continued protection of the customer and service technician.

LEAKAGE CURRENT CHECK

Before returning the unit to the customer, make sure you make either (1) a leakage current check or (2) a line to chassis resistance check. If the leakage current exceeds 0.5 milliamps, or if the resistance from chassis to either side of the power cord is less than 460 kohms, the unit is defective.

Be sure to test for leakage current with the AC plug in both polarities, in addition, in each power ON, OFF and STANDBY mode, if applicable.

CAUTION Please heed the points listed below during servicing and inspection.

⊙ Heed the cautions!

Spots requiring particular attention when servicing, such as the cabinet, parts, chassis, etc., have cautions indicated on labels. Be sure to heed these cautions and the cautions indicated in the handling instructions.

⊙ Caution concerning electric shock!

- (1) An AC voltage is impressed on this set, so touching internal metal parts when the set is energized could cause electric shock. Take care to avoid electric shock, by for example using an isolating transformer and gloves when servicing while the set is energized, unplugging the power cord when replacing parts, etc.
- (2) There are high voltage parts inside. Handle with extra care when the set is energized.

⊙ Caution concerning disassembly and assembly!

Through great care is taken when manufacturing parts from sheet metal, there may in some rare cases be burrs on the edges of parts which could cause injury if fingers are moved across them. Use gloves to protect your hands.

⊙ Only use designated parts!

The set's parts have specific safety properties (fire resistance, voltage resistance, etc.). For replacement parts, be sure to use parts which have the same properties. In particular, for the important safety parts that are marked \triangle on wiring diagrams and parts lists, be sure to use the designated parts.

⊙ Be sure to mount parts and arrange the wires as they were originally!

For safety reasons, some parts use tape, tubes or other insulating materials, and some parts are mounted away from the surface of printed circuit boards. Care is also taken with the positions of the wires and clamps are used to keep wires away from heating and high voltage parts, so be sure to set everything back as it was originally.

⊙ Inspect for safety after servicing!

Check that all screws, parts and wires removed or disconnected for servicing have been put back in their original positions, inspect that no parts around the area that has been serviced have been negatively affected, conduct an insulation check on the external metal connectors and between the blades of the power plug, and otherwise check that safety is ensured.

(Insulation check procedure)

Unplug the power cord from the power outlet, disconnect the antenna, plugs, etc., and turn the power switch on. Using a 500V insulation resistance tester, check that the inplug and the externally exposed metal parts (antenna terminal, headphones terminal, input terminal, etc.) is 1M Ω or greater. If it is less, the set must be inspected and repaired.

CAUTION Concerning important safety parts

Many of the electric and structural parts used in the set have special safety properties. In most cases these properties are difficult to distinguish by sight, and using replacement parts with higher ratings (rated power and withstand voltage) does not necessarily guarantee that safety performance will be preserved. Parts with safety properties are indicated as shown below on the wiring diagrams and parts lists in this service manual. Be sure to replace them with parts with the designated part number.

(1) Schematic diagrams Indicated by the \triangle mark.

(2) Parts lists Indicated by the \triangle mark.

Using parts other than the designated parts could result in electric shock, fires or other dangerous situations.

NOTE FOR SCHEMATIC DIAGRAM

WARNING:

Parts marked with this symbol \triangle have critical characteristics. Use ONLY replacement parts recommended by the manufacturer.

CAUTION:

Before returning the unit to the customer, make sure you make either (1) a leakage current check or (2) a line to chassis resistance check. If the leakage current exceeds 0.5 milliamps, or if the resistance from chassis to either side of the power cord is less than 460 kohms, the unit is defective.

WARNING:

DO NOT return the unit to the customer until the problem is located and corrected.

NOTICE:

ALL RESISTANCE VALUES IN OHM. k=1,000 OHM / M=1,000,000 OHM

ALL CAPACITANCE VALUES IN MICRO FARAD. P=MICRO MICRO FARAD EACH VOLTAGE AND CURRENT ARE MEASURED AT NO SIGNAL INPUT CONDITION. CIRCUIT AND PARTS ARE SUBJECT TO CHANGE WITHOUT PRIOR NOTICE.

NOTE FOR PARTS LIST

PARTS INFORMATION

RESISTORS

1) 00MGD05 xxx 140, Carbon film fixed resistor, $\pm 5\%$ 1/4W

2) 00MGD05 xxx 160, Carbon film fixed resistor, $\pm 5\%$ 1/6W

① Resistance value

Examples ;

① Resistance value

0.1 Ω001	10 Ω100	1k Ω102	100k Ω104
0.5 Ω005	18 Ω180	2.7k Ω272	680k Ω684
1 Ω010	100 Ω101	10k Ω103	1M Ω105
6.8 Ω068	390 Ω391	22k Ω223	4.7M Ω475

Note : Please distinguish 1/4W from 1/6W by the shape of parts used actually.

CAPACITORS

CERAMIC CAP.

3) 00MDD1 xxx 370,



Examples ;

② Tolerance (Capacity deviation)
 $\pm 0.25\text{pF}$ 0
 $\pm 0.5\text{pF}$ 1
 $\pm 5\%$ 5

* Tolerance of COMMON PARTS handled here are as follows :

0.5pF ~ 5pF $\pm 0.25\text{pF}$
 6pF ~ 10pF $\pm 0.5\text{pF}$
 12pF ~ 560pF $\pm 5\%$

③ Capacity value

0.5pF005	3pF030	100pF 101
1pF010	10pF100	220pF221
1.5pF015	47pF470	560pF561

CERAMIC CAP.

4) 00MDK16 xxx 300,

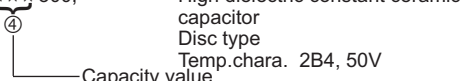

Examples ;

④ Capacity value

100pF101	1000pF 102	10000pF103
470pF471	2200pF 222	

ELECTROLY CAP. (Z)

5) 00MEA xxx xxx 10,

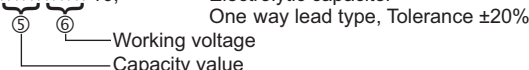

Examples ;

⑤ Capacity value

0.1 μF104	4.7 μF475	100 μF ... 107
0.33 μF334	10 μF106	330 μF ... 337
1 μF105	22 μF226	1100 μF ... 118
		2200 μF ... 228

⑥ Working voltage

6.3V.....006	25V.....025
10V.....010	35V.....035
16V.....016	50V.....050

FILM CAP. (Z)

6) 00MDF15 xxx 350

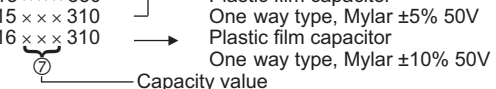

Examples ;

⑦ Capacity value

0.001 μF (1000pF)102	0.1 μF 104
0.0018 μF182	0.56 μF ... 564
0.01 μF103	1 μF 105
0.015 μF153	

NOTE ON SAFETY FOR FUSIBLE RESISTOR :

The suppliers and their type numbers of fusible resistors are as follows;

1. KOA Corporation

Part No. (MJI)	Type No. (KOA)	Description
00MNH05 xxx 140	RF25S xxx Ω J	($\pm 5\%$ 1/4W)
00MNH05 xxx 120	RF50S xxx Ω J	($\pm 5\%$ 1/2W)
00MNH85 xxx 110	RF73B2A xxx Ω J	($\pm 5\%$ 1/10W)
00MNH95 xxx 140	RF73B2E xxx Ω J	($\pm 5\%$ 1/4W)

* Resistance value Resistance value (0.1 - 10k Ω)

2. Matsushita Electronic Components Co., Ltd

Part No. (MJI)	Type No. (MEC)	Description
00MNF05 xxx 140	ERD 2FCJ xxx	($\pm 5\%$ 1/4W)
00MRF05 xxx 140		
00MNF02 xxx 140	ERD 2FCG xxx	($\pm 2\%$ 1/4W)
00MRF02 xxx 140		

* Resistance value * Resistance value

Examples ;

* Resistance value			
0.1 Ω001	10 Ω100	1k Ω102	100k Ω104
0.5 Ω005	18 Ω180	2.7k Ω272	680k Ω684
1 Ω010	100 Ω101	10k Ω103	1M Ω105
6.8 Ω068	390 Ω391	22k Ω223	4.7M Ω475

ABBREVIATION AND MARKS

ANT. : ANTENNA	BATT. : BATTERY
CAP. : CAPACITOR	CER. : CERAMIC
CONN. : CONNECTING	DIG. : DIGITAL
HP : HEADPHONE	MIC. : MICROPHONE
μ PRO : MICROPROCESSOR	REC. : RECORDING
RES. : RESISTOR	SPK : SPEAKER
SW : SWITCH	TRANSF. : TRANSFORMER
TRIM. : TRIMMING	TRS. : TRANSISTOR
VAR. : VARIABLE	X'TAL : CRYSTAL

NOTE ON FUSE :

Regarding to all parts of parts code **00MFS20xxx2xx**, replace only with Wickmann Werke GmbH, Type 372 non glass type fuse.

NOTE ON SAFETY :

Symbol \triangle Fire or electrical shock hazard. Only original parts should be used to replaced any part marked with symbol \triangle . Any other component substitution (other than original type), may increase risk of fire or electrical shock hazard.

安全上の注意 :

\triangle がついている部品は、安全上重要な部品です。必ず指定されている部品番号の部品を使用して下さい。

TECHNICAL SPECIFICATIONS



Power output

(20 Hz – 20 kHz simultaneous drive of both channels)
 [N][U] 70W x 2 (8Ω load)
 [K] 65W x 2 (8Ω load)
 [N][U] 100W x 2 (4Ω load)
 [K] 9W x 2 (4Ω load)

Total harmonic distortion

(20Hz – 20kHz simultaneous drive of both channels, 8Ω load)
 0.02%

Output band width (8Ω load, 0.05%)

.....5Hz – 60kHz

Frequency response (CD, 1W, 8Ω load)

.....5Hz – 100kHz ±3dB

Dumping factor (8Ω load, 20Hz – 20kHz)

.....100

Input sensitivity/Input impedance

PHONO (MM).....2mV/47kΩ
 CD, TUNER, AUX/DVD, RECORDER
200mV/20kΩ
 MAIN IN1.6V/15kΩ

Output band width/Output impedance

PRE OUT 1.6V/600Ω

Maximum allowable PHONO input level (1kHz)

MM 100mV

RIAA deviation (20Hz ~ 20kHz)

..... ±0.5dB

S/N (IHF-A, 8Ω load)

PHONO (MM)..... 87dB (5mV input, 1W output)

CD, TUNER, AUX/DVD, RECORDER

..... 106dB (2V input, Rated output)

POWER AMP DIRECT IN 125dB (Rated output)

Tone control

Bass (50Hz)..... ±10dB

Mid (900Hz) ±6dB

Treble (15kHz)..... ±10dB

Power requirement

[N] AC 230 V, 50/60 Hz

[U] AC 120 V, 60 Hz

[K] AC 220V,50Hz

Power consumption

(EN60065)..... 200W

Standby power consumption..... 0.3W

Weight (Amplifier)

[N1] 11.2kg

[N2] 11.8kg

[U][K] 12.2kg

* SPECIFICATION for China is different from SPECIFICATION of instruction manual in description.

DIMENSION



[N1][U][K]

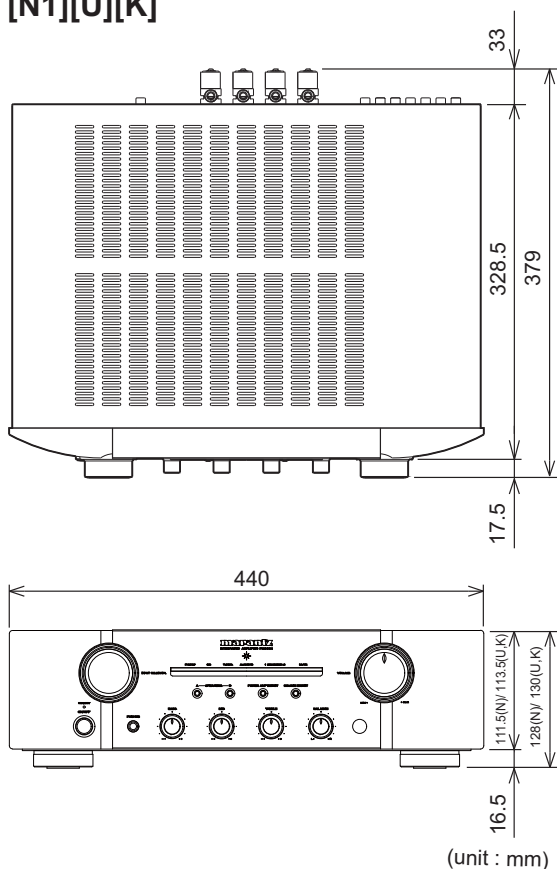

[N2]

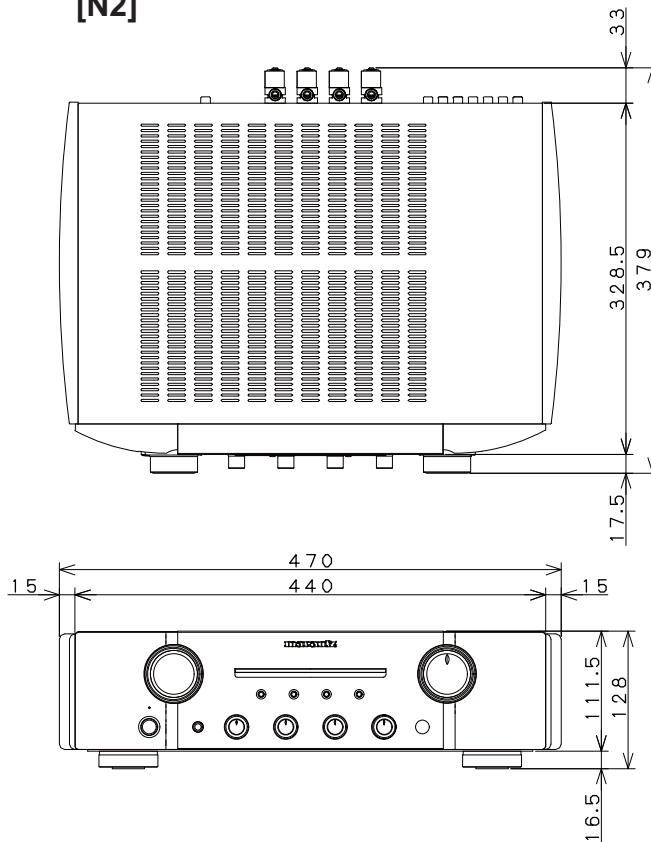

DISASSEMBLY

- Disassemble in order of the arrow of the figure of following flow.
- In the case of the re-assembling, assemble it in order of the reverse of the following flow.
- In the case of the re-assembling, observe "attention of assembling" it.
- If wire bundles are untied or moved to perform adjustment or parts replacement etc., be sure to rearrange them neatly as they were originally bundled or placed afterward.
Otherwise, incorrect arrangement can be a cause of noise generation.

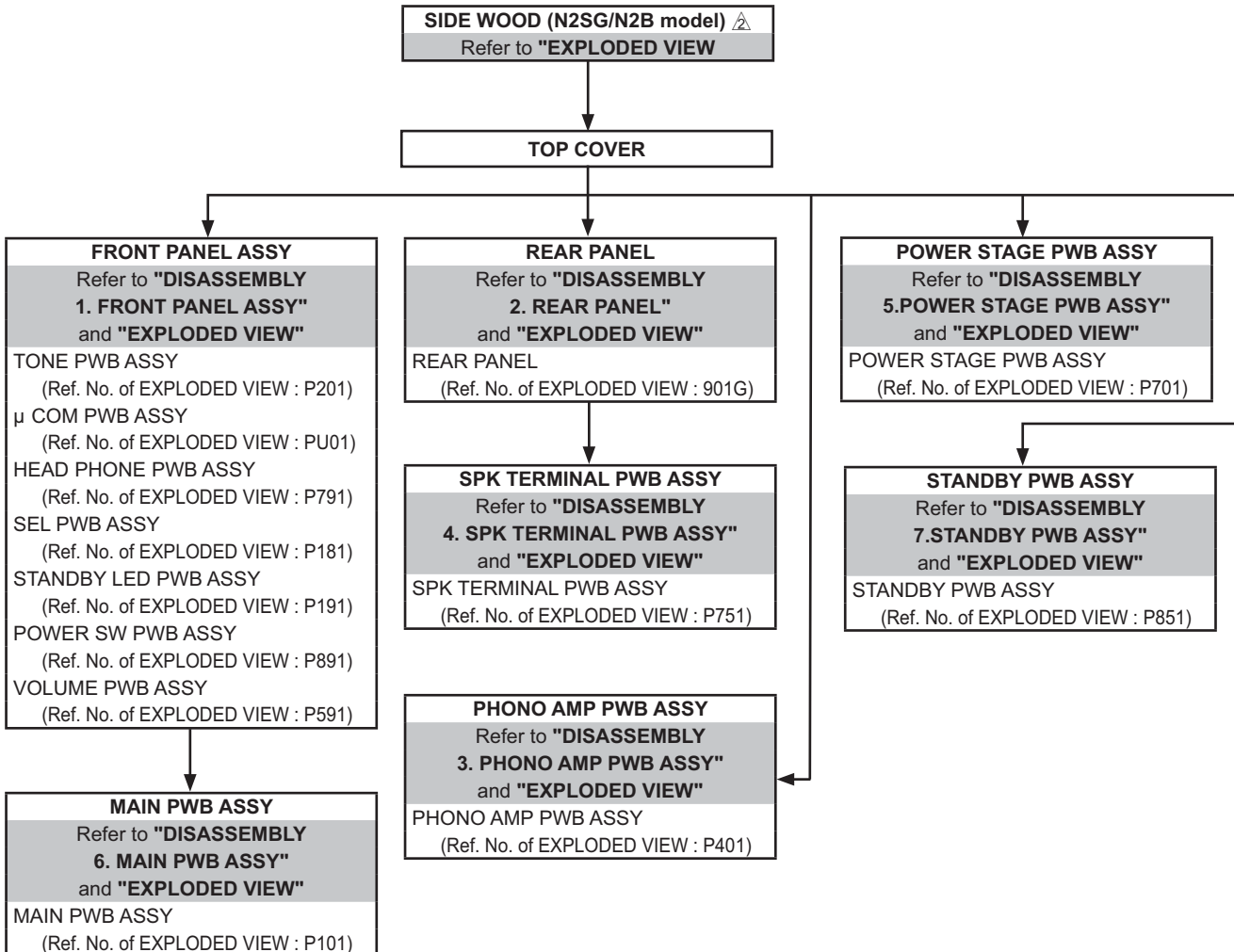

About the photos used for descriptions in the DISASSEMBLY" section.

- The direction from which the photographs used herein were photographed is indicated at "Direction of photograph: ****" at the left of the respective photographs.
- Refer to the table below for a description of the direction in which the photos were taken.
- Photographs for which no direction is indicated were taken from above the product.
- The photograph is PM-KI-PEARL-LITE.

The viewpoint of each photograph (Photografy direction)

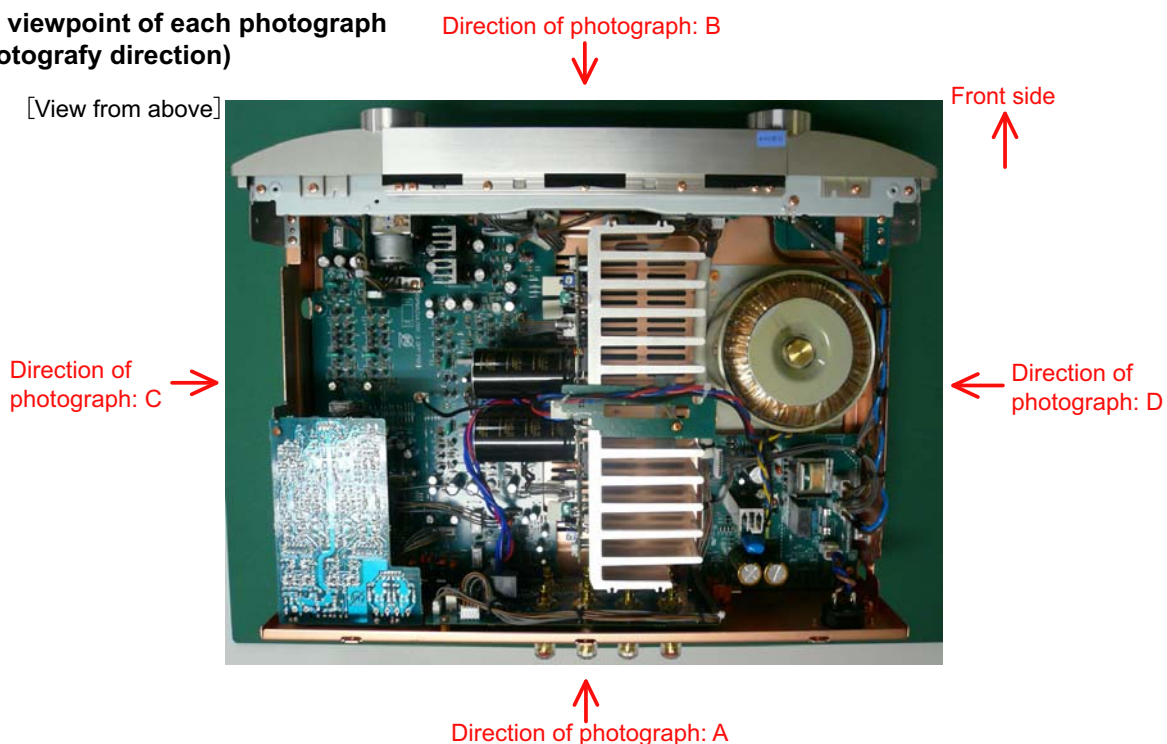

1. FRONT PANEL ASSY

Proceeding : **TOP COVER** → **FRONT PANEL ASSY**

- (1) Remove the screws.



- (2) Remove the screws.



(3) Remove the screws.

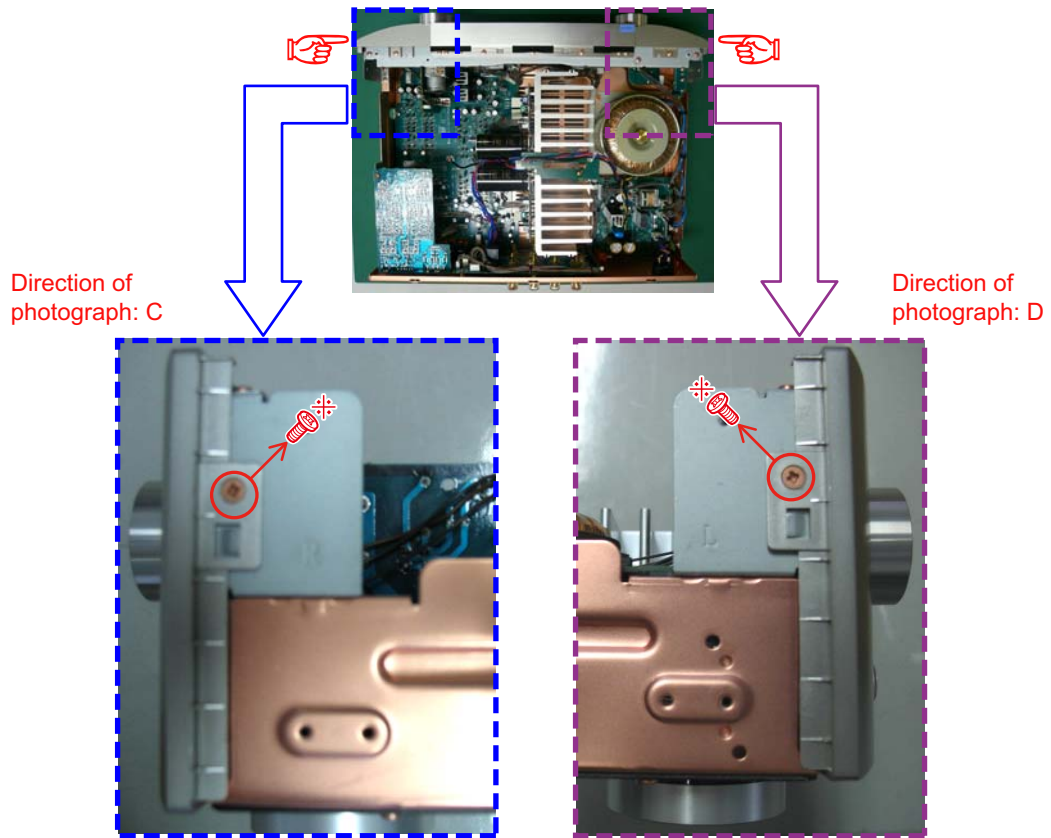

(4) Cut the wire clamp band, then disconnect the connector wires. Remove the screws.

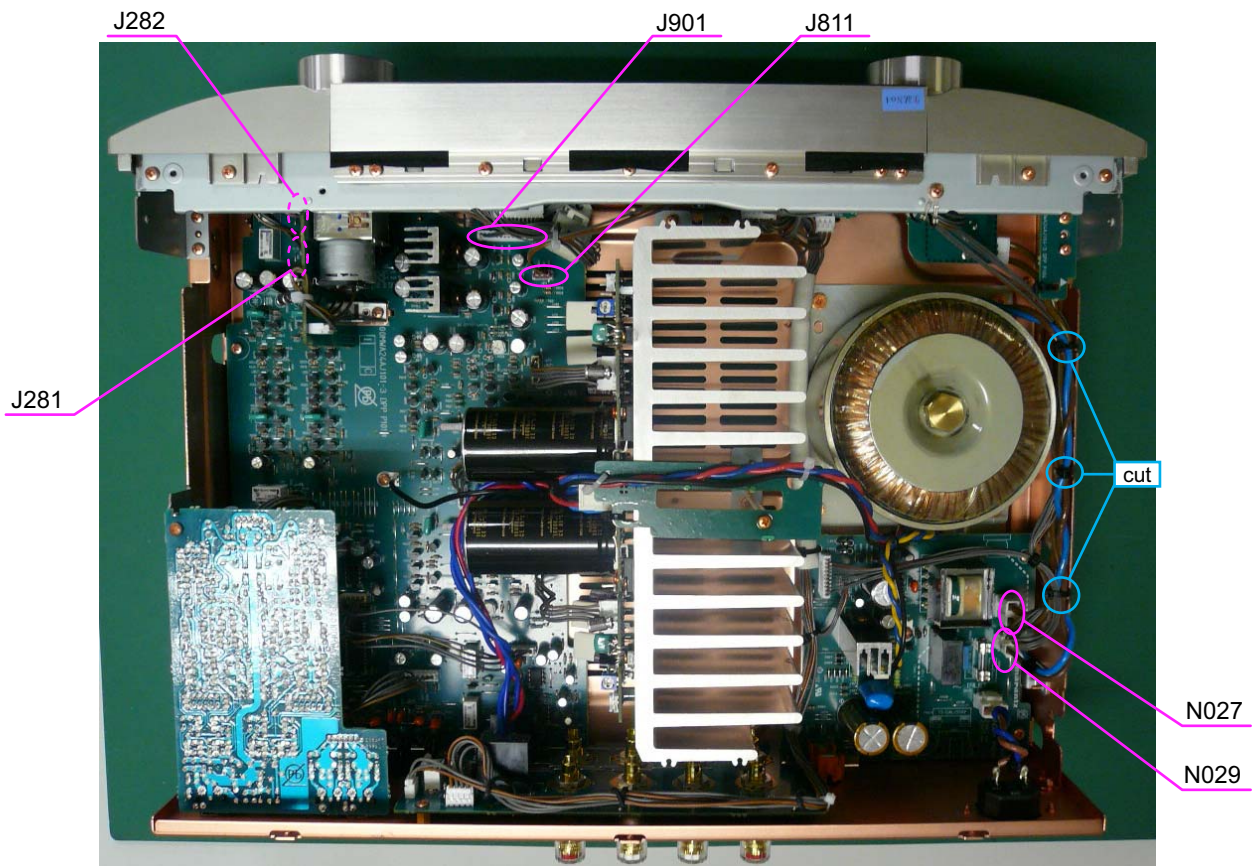

(5) Remove the nut.

Direction of photograph: B



2. REAR PANEL

Proceeding : **TOP COVER** → **REAR PANEL**

(1) Remove the screws.

Direction of photograph: A



3. PHONO AMP PWB ASSY

Proceeding : **TOP COVER** → **PHONO AMP PWB ASSY**

(1) Remove the screws.

Direction of photograph: A



(2) Disconnect the connector wires. Remove the screws.

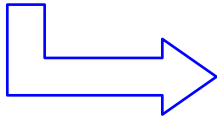
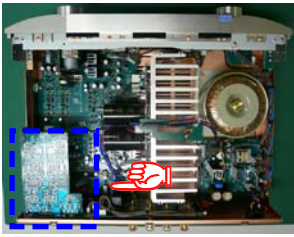

Direction of photograph: D

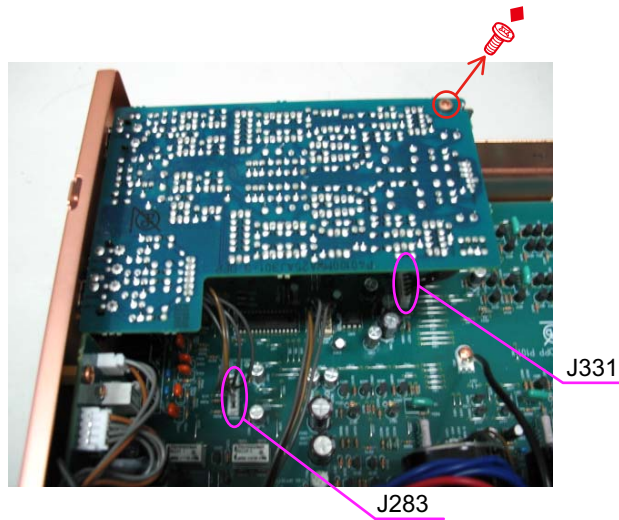

4. SPK TERMINAL PWB ASSY

Proceeding : **TOP COVER** → **REAR PANEL** → **SPK TERMINAL PWB ASSY**

(1) Cut the wire clamp band, then disconnect the connector wires.

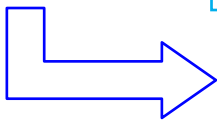
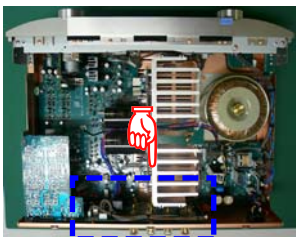

Direction of photograph: B

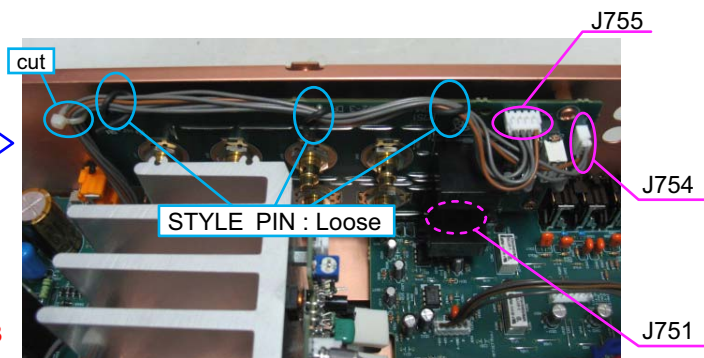

(2) Remove the nuts and the screws.

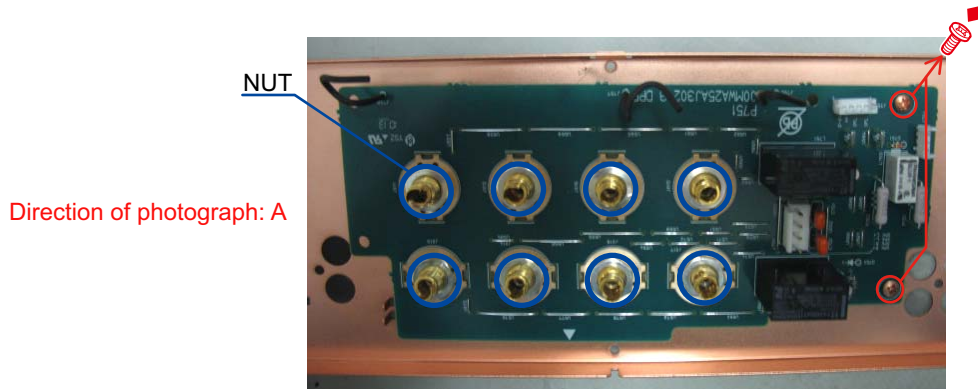

5. POWER STAGE PWB ASSY

Proceeding : **TOP COVER** → **POWER STAGE PWB ASSY**

(1) Cut the wire clamp band, then disconnect the connector wires. Remove the screws.

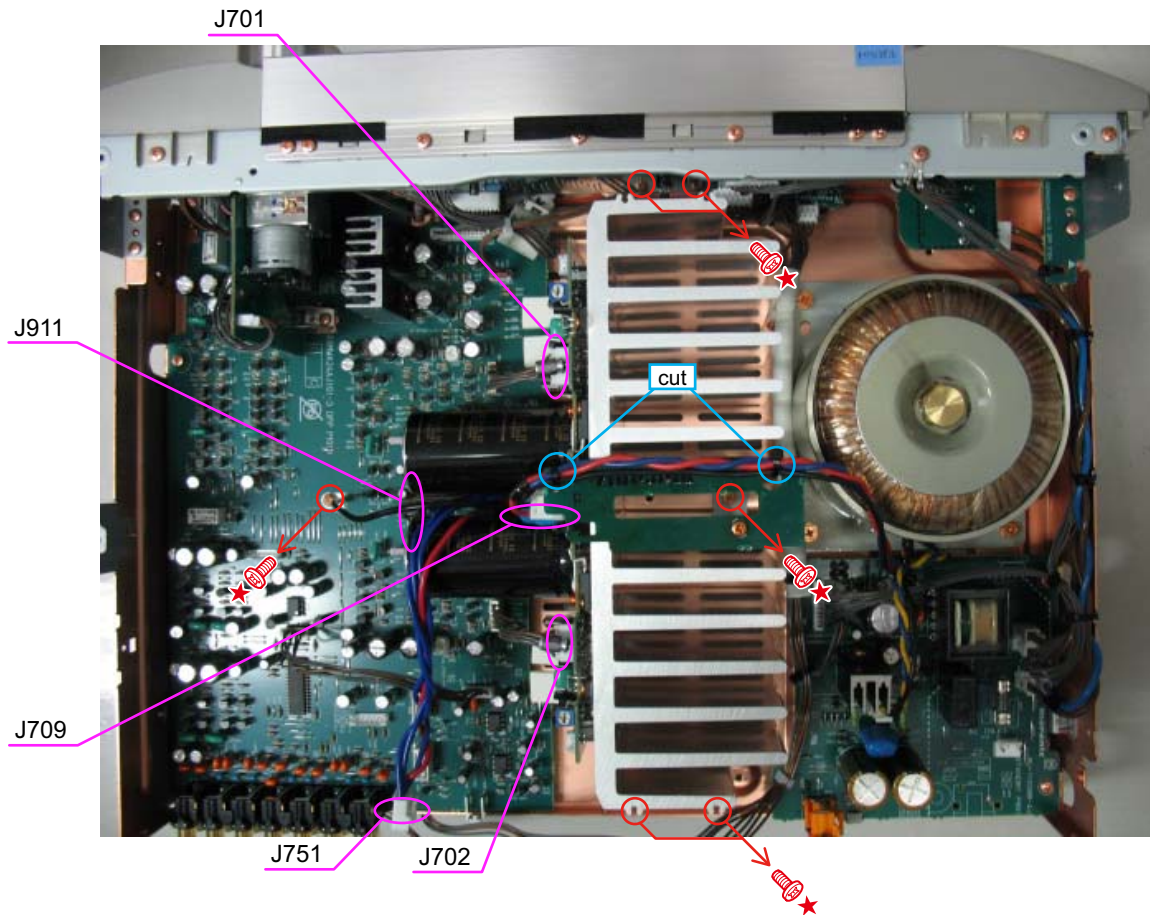

(2) Cut the wire clamp band, then remove the screws.

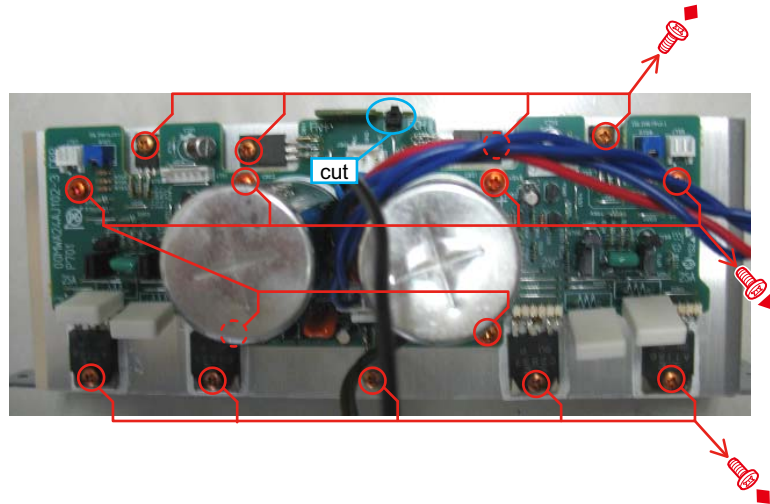

Direction of photograph: C

6. MAIN PWB ASSY

Proceeding : **TOP COVER** → **FRONT PANEL ASSY** → **MAIN PWB ASSY**

(1) Remove the screws.



Direction of photograph: A

(2) Disconnect the connector wires. Remove the screws.

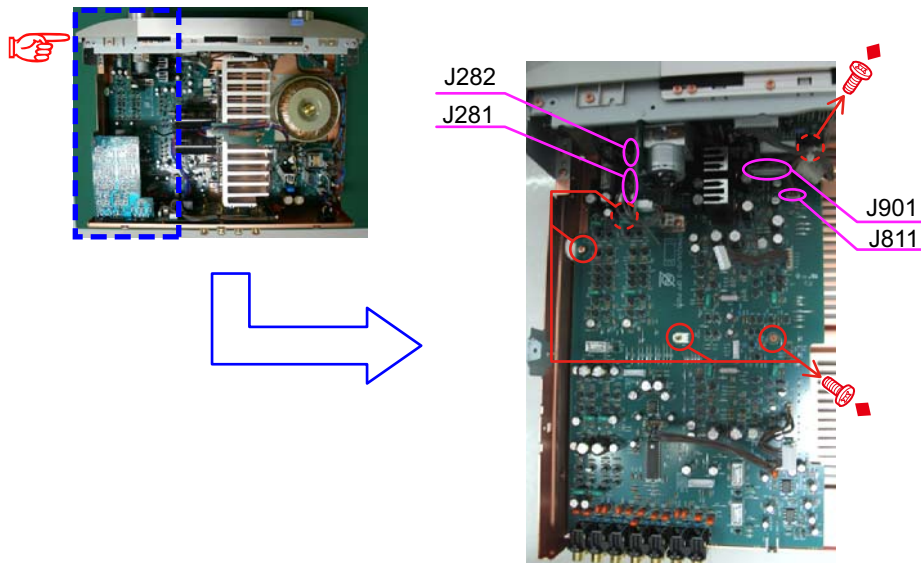

7. STANDBY PWB ASSY

Proceeding : **TOP COVER** → **STANDBY PWB ASSY**

- (1) Cut the wire clamp band, then disconnect the connector wires. Remove the screws.

Direction of photograph: A



- (2) Cut the wire clamp band, then disconnect the connector wires. Remove the screws.

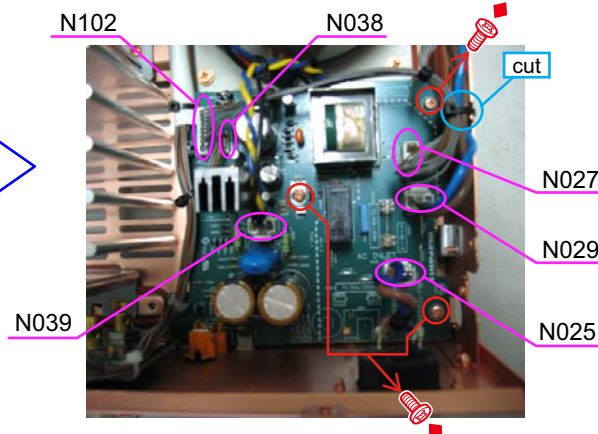
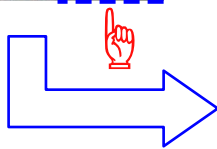
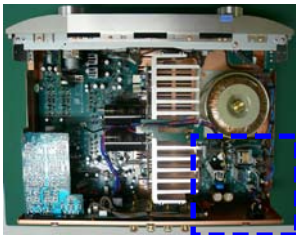

SERVICE MODE

Microprocessor (U101) version check

- (1) Connect the mains cord into the unit.
- (2) Press the POWER button with pressing the SOURCE DIRECT button on the Unit.
- (3) The firmware version is displayed on the front LED. (Display time is only for 3 seconds.)

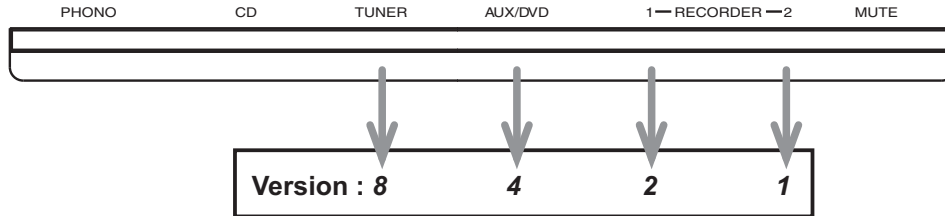

The firmware version is displayed in the lighting position of LED.

Ex. :

Light up RECORDER-2 [1], **Version : 1**

Light up RECORDER-2 [1] and AUX/DVD [4], **Version : 5**

Light up RECORDER-2 [1] and CD [8], **Version : 9**

- (4) Each LED light up then all LED light up.
- (5) Turn off the power to quit Service Mode. (The unit to the default status)

PROTECTION MODE

Explanation of microprocessor (U101) [PROT-1 (pin6) and PROT-2 (pin7)].

1. The PROT-1 (pin6) is the port to detect the following abnormalities of the Power AMP

- (1) Detection of an abnormality in the DC offset voltage from the Speaker Output terminal.
If the voltage from the Speaker Output terminal exceeds approximately 1.2V (DC), Q955 or Q956 will turn on and the signal from the PROT-1 terminal will change to "L" from "H".
- (2) Detection of an abnormal current from the power transistors (Q713 ~ Q716).
If an electric current of over 7A flows in Q713 or Q715, Q951, Q953 and Q957 turn on, and the signal from the PROT-1 terminal will change to "L" from "H".
If an electric current of over 7A flows in Q714 or Q716, Q952, Q954 and Q957 turn on, and the signal from the PROT-1 terminal will change to "L" from "H".
- (3) Detection of an abnormal temperature of the Heat Sink.
If the temperature of the Heat Sink exceeds approximately +110 degrees C, the resistor (R969) will turn on Q958 and the signal from the PROT-1 terminal will change to "L" from "H".

If any of the above three abnormalities is detected, the signal from the PROT-1 terminal will change to "L" from "H", and the protection circuit will be activated, the signal from the SPK_OUT (pin10) changing to "H" from "L" and the speaker relays L751, L752 and L753 immediately turned off.

What this protection operation results in after this depends on how long the signal from the PROT-1 has to remain "L".

- If the PROT-1 (pin6) recovers to "H" within as short a period of time as one second or less.
The MUTE indicator starts flickering, thereby indicates that the protection circuit has come into operation and automatically turns down the volume. The protection circuit is deactivated after approximately 15 seconds, so that readjusting the volume will allow normal use of the unit again. This protection operation is intended for the situation wherein the user has misused the unit temporarily and automatically resets the unit while the amp circuit is functioning properly.
- If the PROT-1 (pin6) remains "L" for more than one second.
The amp will be powered off by the P_ON (pin15) changing to "H" from "L" and Power relay S851 turned off Then, the STANDBY indicator flickers, thereby indicating that an error has occurred. This protection operation is intended for a failure in the amp circuit and immediately turns the power off to avoid the risk of any damage.
Depending on how the user is handling the unit, this operation may be performed no matter if the amp is functioning properly.

To check if the amp is in order, switch off the unit and switch it on again one minute later. This action will deactivate the protection operation. If the PROT-1 (pin6) remains "L", which constitutes an abnormality, the unit shuts down approximately 3 seconds later and the STANDBY indicator starts flickering.
If the protection operation will not be deactivated after the power is turned on again, the amp circuit may be broken.

2. The PROT-2 (pin7) is the port to detect abnormalities of the power supply circuit.

- (1) Detection of an abnormality in the power amp power supply circuit.
This port monitors the midpoint voltage of the power amp power supply between +49V and -49V. If the voltage at the connection point of R801 and R802 exceeds DC $\pm 1.2V$, Q903 or Q904 will turn on to change the signal from the PROT-2 (pin7) to "L" from "H".
- (2) Detection of an abnormality in the preamp power supply circuit.
Q901 and Q902 monitor the midpoint voltage between +28V and -28V. If the voltage at the connection point of R905 and R906 exceeds DC $\pm 1.2V$, Q901 or Q902 will turn on to change the signal from the PROT-2 (pin7) to "L" from "H".
- (3) Detection of an abnormality in the function relay power supply circuit.
If the +24VL of the relay power supply receives an electric current of over 80 mA, Q815 and Q901 will turn on to change the signal from the PROT-2 (pin7) to "L" from "H".

If any of the above three abnormalities is detected, the signal from the P_ON (pin15) terminal will be changed to "L" from "H", the power relay S851 will be turned off and the unit will be shut down. Then, the STANDBY indicator flickers and indicates that an abnormality has occurred.

This protection operation is intended for a breakdown of the AMP circuit or the power supply circuit and immediately shuts off the power in order to avoid the risk of damage.

To check if the amp circuit or the power supply circuit is broken, switch off the power and then switch it on again one minute later. This action will deactivate the protection operation.

If the PROT-2 (pin7) remains "L" after the power is switched on again, the unit will be shut down again three seconds later with the STANDBY indicator flickering.

If the unit is powered on again and yet cannot get the protection operation deactivated, the amp circuit or the power supply circuit may be broken.

VERSION UPGRADE PROCEDURE OF FIRMWARE

ABOUT REPLACE THE MICROPROCESSOR WITH A NEW ONE

When replaced of the U-PRO (Microprocessor) or the Flash ROM, confirm contents of the following.

PWB Name	Ref. No.	Description	After replaced	Remark
FRONT	U101	TMP86FH47UG	C	

After replaced

- A :** Mask ROM (With software). No need write-in of software to the microprocessor.
- B :** Flash ROM (With software). Usually, no need write-in of software. But, when the software was updated, you should be write-in of the new software to the microprocessor or flash ROM. Please check the software version.
- C :** Empty Flash ROM (Without software). You should be write-in of the software to the microprocessor or flash ROM. Refer to "Update procedure" or "writing procedure", when you should be write-in the software.

Necessary Equipment

- Windows PC (OS: Windows 2000 or Windows XP) with Serial port.
- RS-232C Cable straight type (9 Pin female - 9 Pin female)
- Connection JIG (90M-PM11S1JIG)
- Writing Tool and some files (FlashProg.exe, etc... in TM86FH47pass folder)
- Writing data (PM7004_ xxxx.h16)

WRITING PROCEDURE

- (1) Disconnect the mains cord from the unit.
- (2) Connect RS-232C on the connection JIG and Serial Port of windows PC with RS-232C cable.
- (3) Connect FPC (upside contact) to the rear panel of the unit from connection JIG.

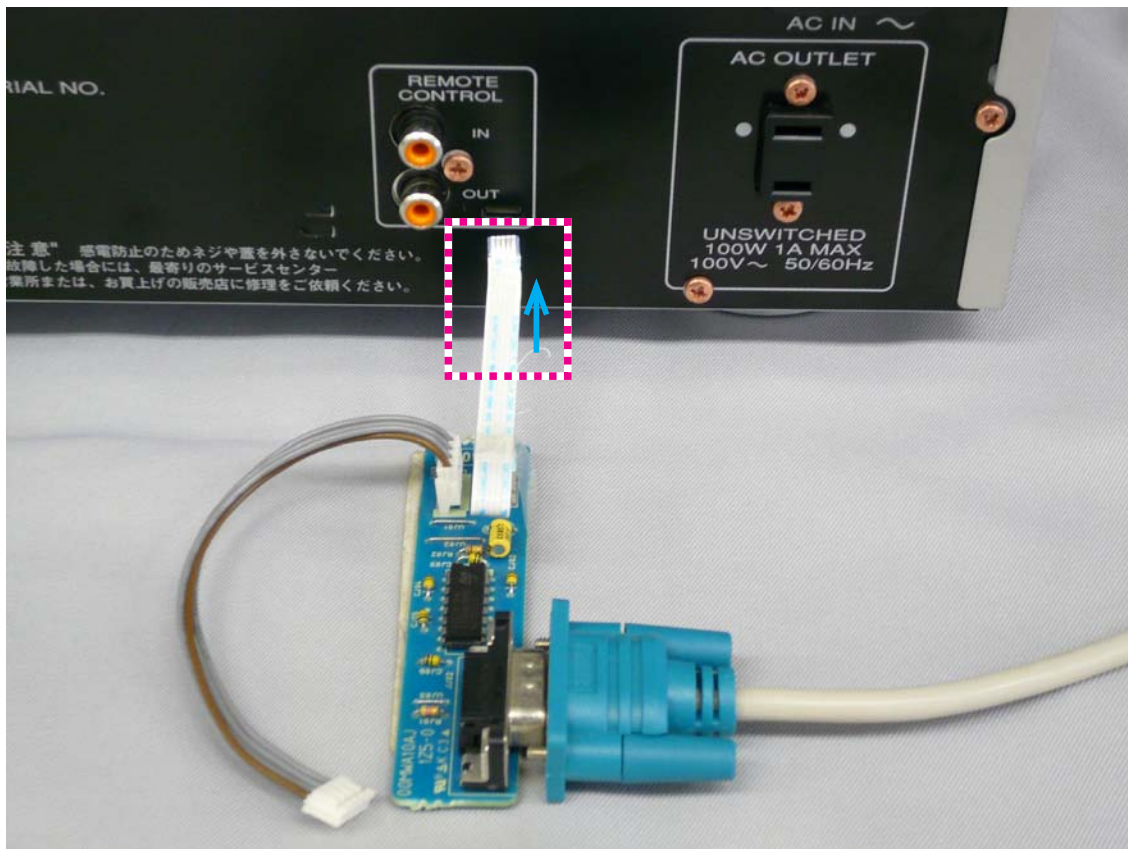

- (4) Reconnect the mains cord to the unit.
- (5) Put the "TM86FH47pass" folder into anywhere on your PC's hard disc.

(6) Double click the TM86FH47pass folder.

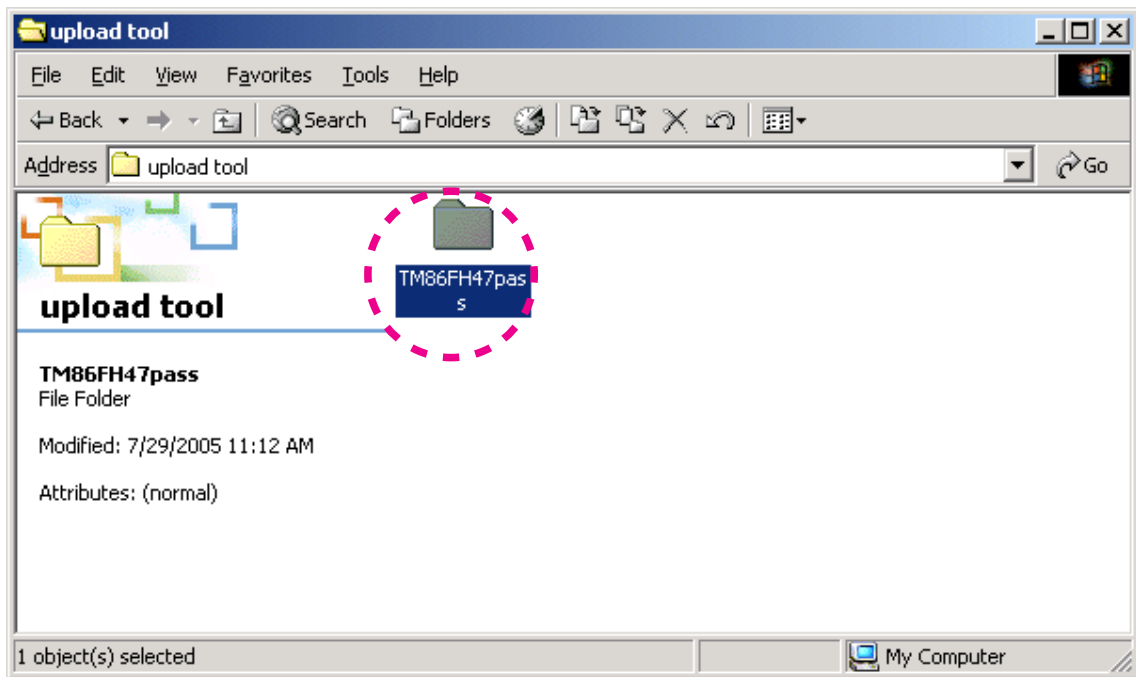

(7) Double click FlashProg.exe.

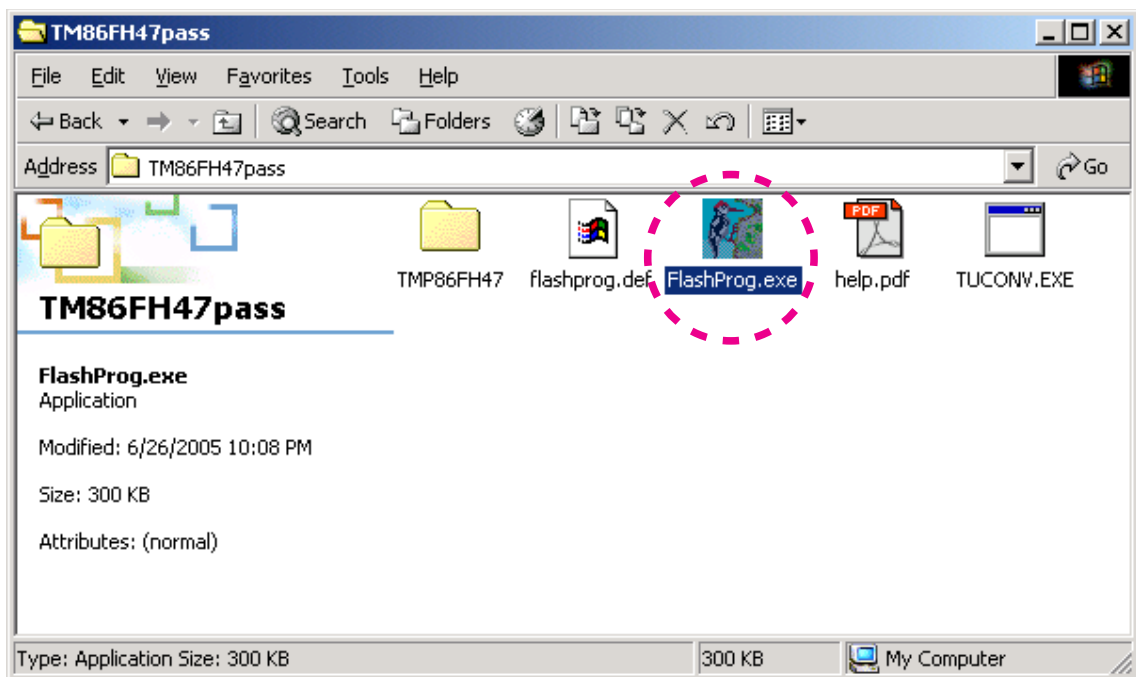

(8) Click Device tab.

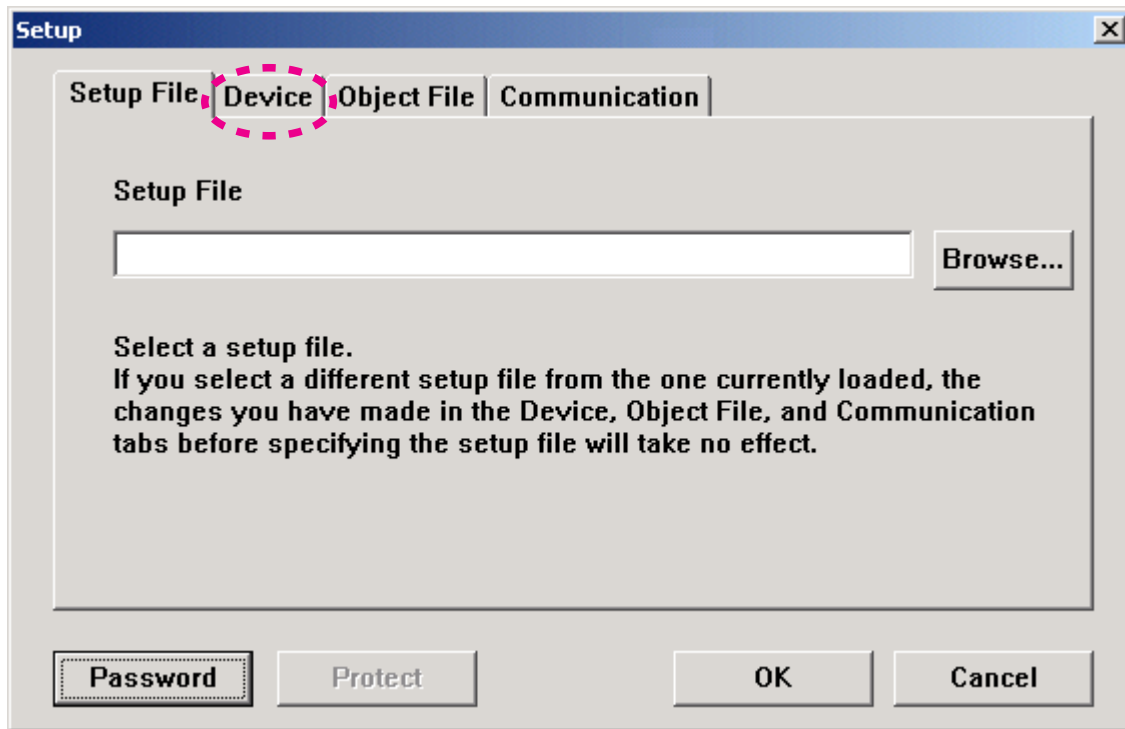

(9) Click Apply.

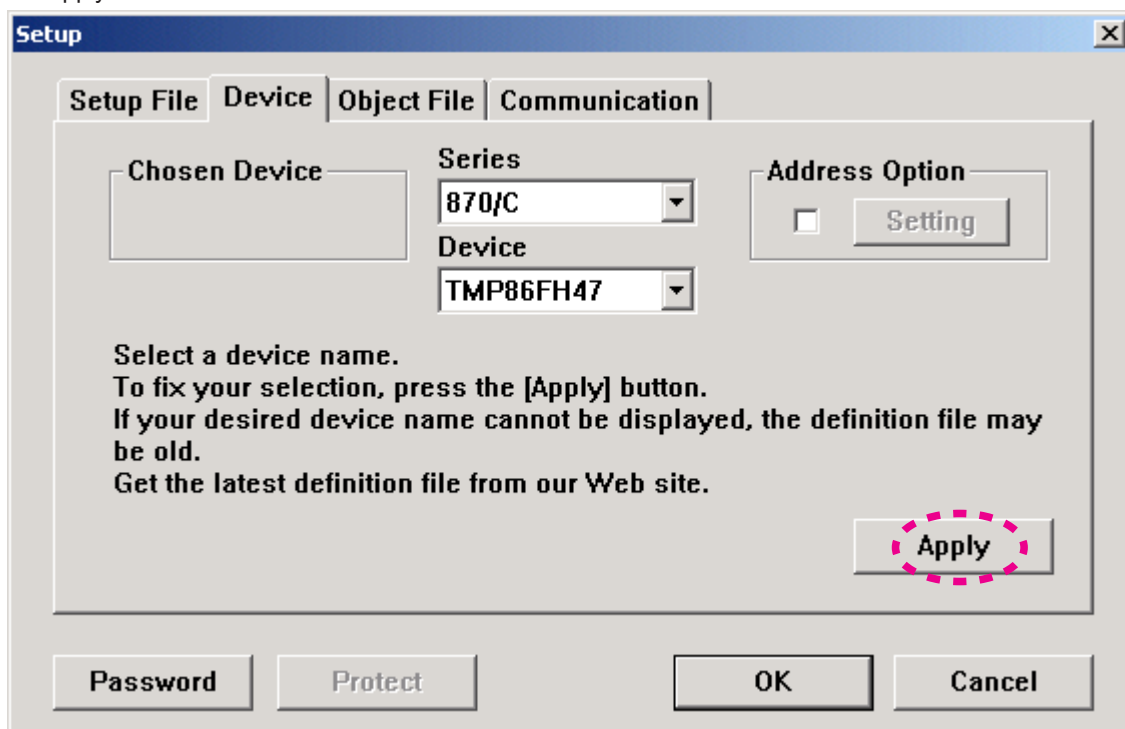

(10) TMP86FH47 appear in Chosen Device.

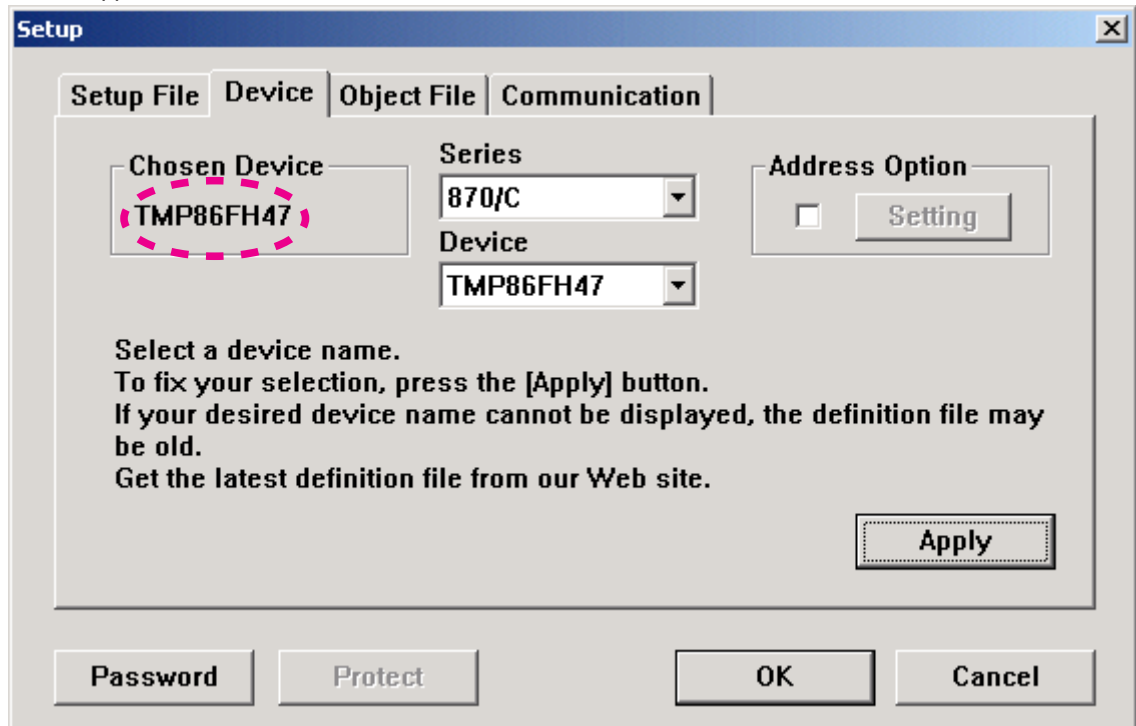

(11) Click Object File, and click Browse...

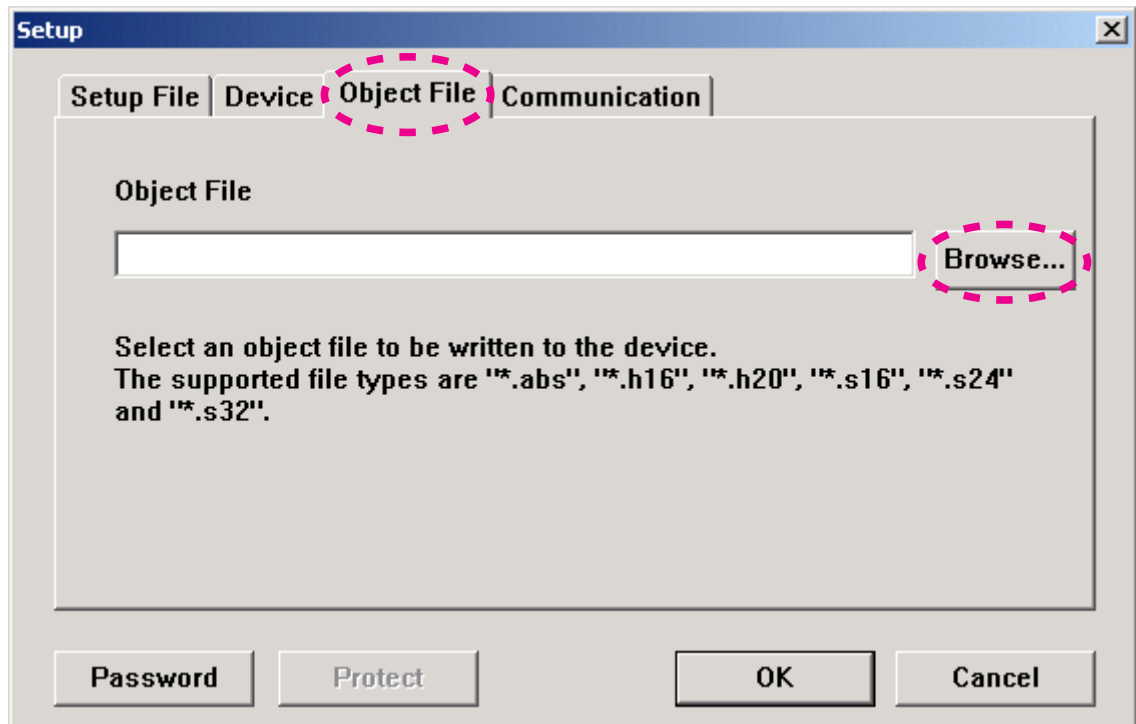

- (12) Choose iHEX Format[*.*h16,*.h20] in Files of type.
Choose writing data, and click Open.

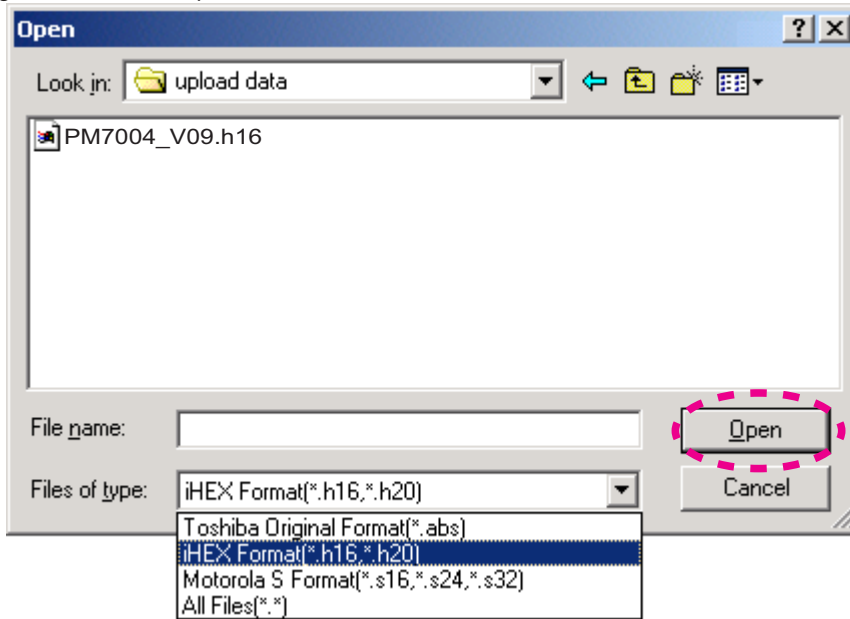

- (13) Click Communication tab.

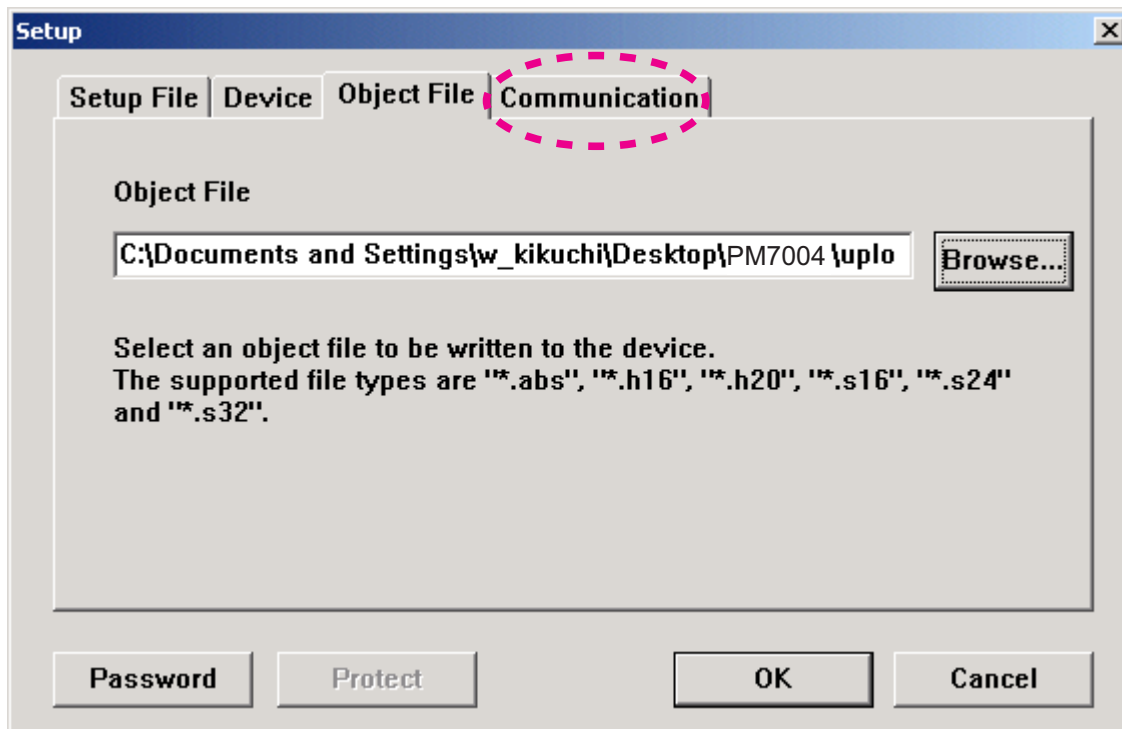

- (14) Choose COM port number in COM port.
Choose 9600 in Data Rate.
Click OK.

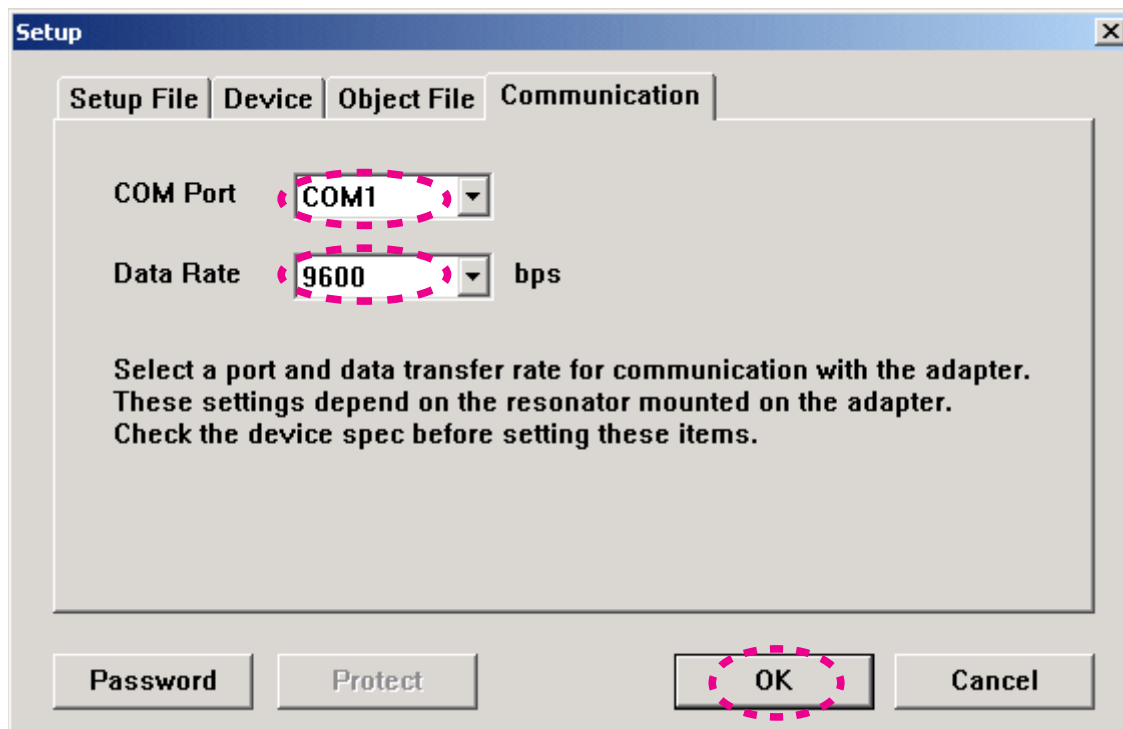

- (15) When Setup window is closed, the tmp folder and FlashProg.ini file are created simultaneously.
Click Yes.

NOTE : These are the original set-up configuration files for that PC. They do not operate, if these files moved to another PC. When you make it operate with other PC, delete the tmp folder and the FlashProg.ini file and redo a setup.

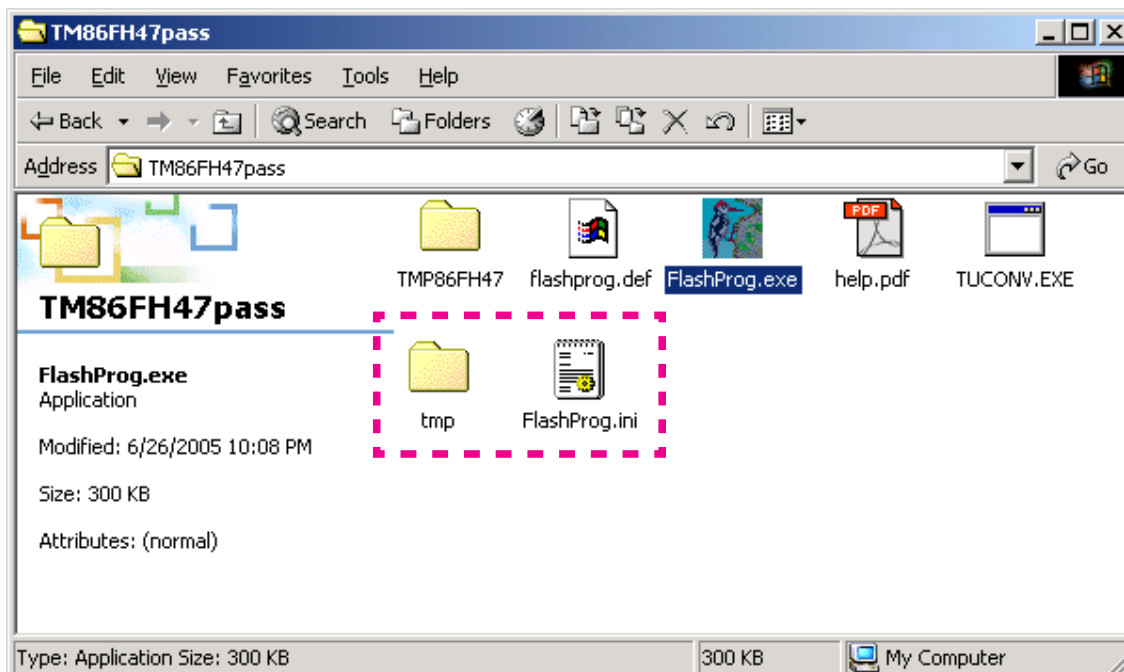

(16) The Flash Programmer is launched.

Click setup icon.

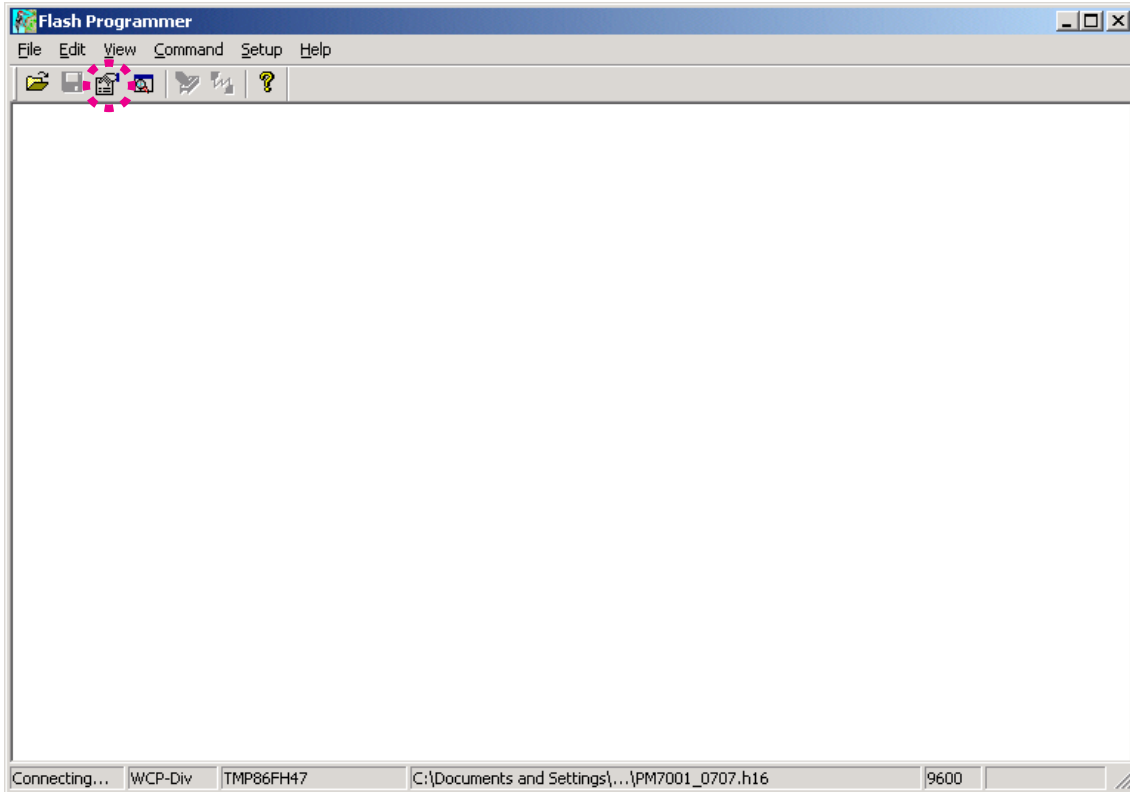

(17) Click Browse....

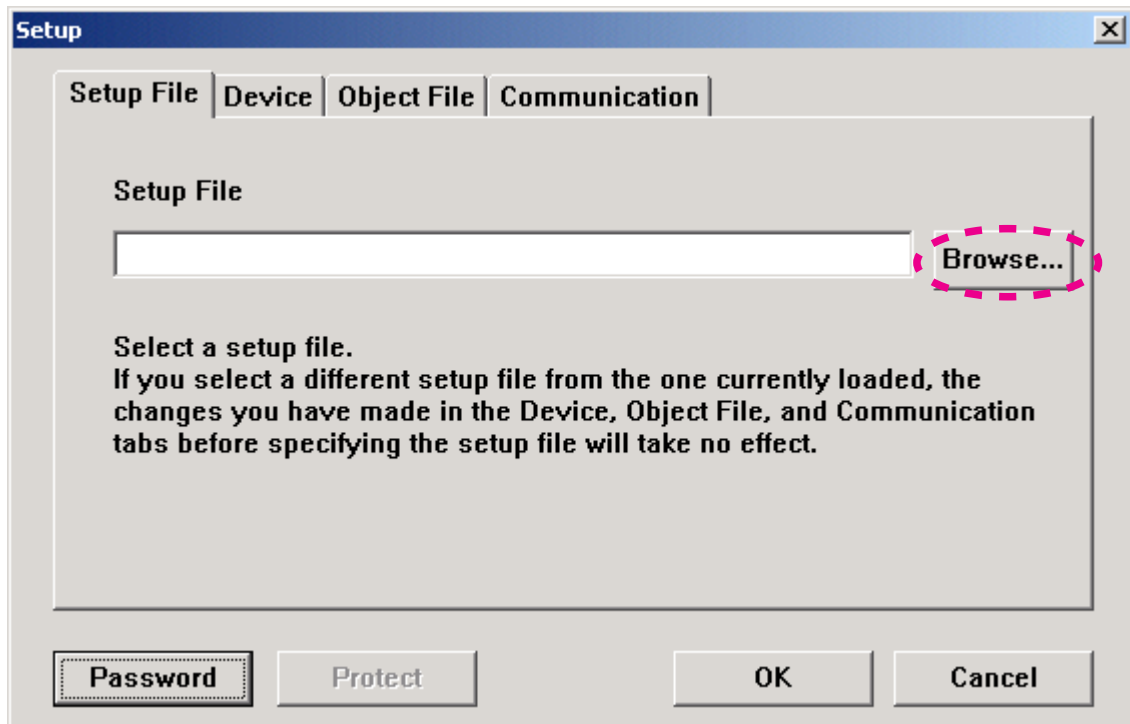

(18) Choose FlashProg.ini in TM86FH47pass folder, and click Open.

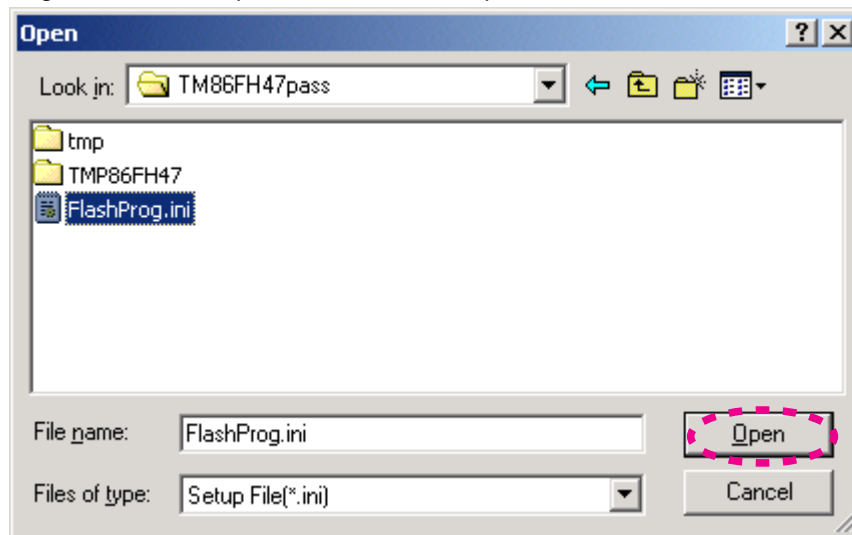

(19) Click OK.

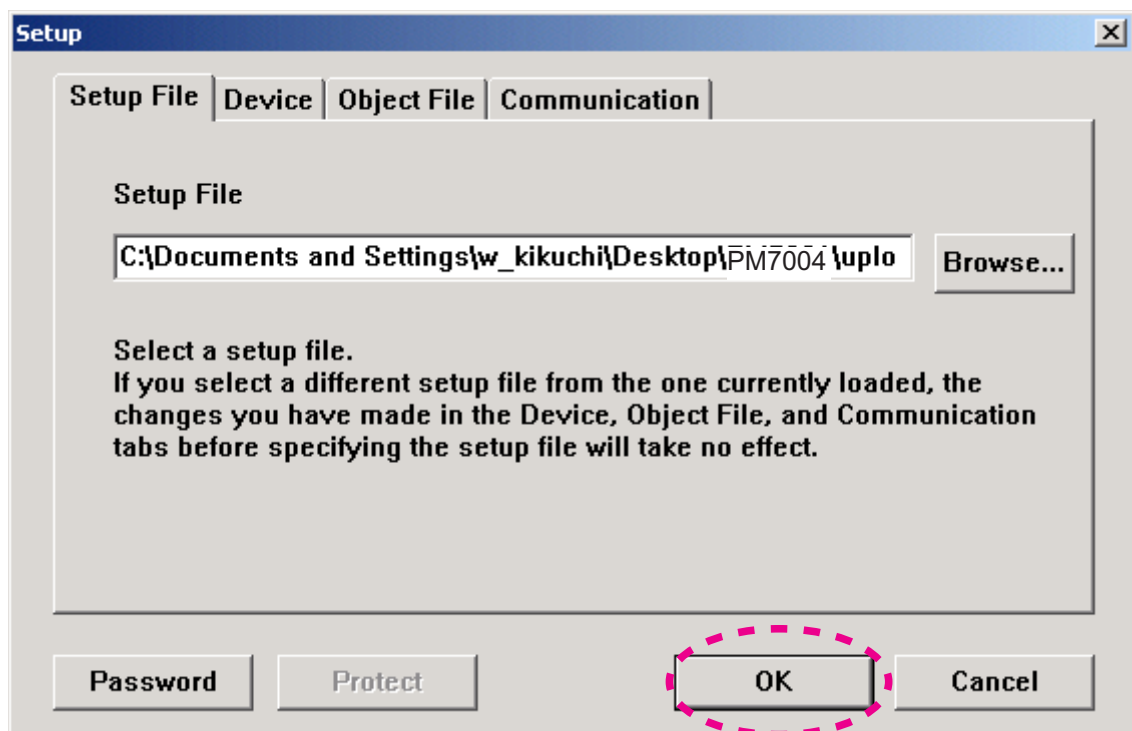

- (20) Press the POWER ON/OFF button, and turn on the unit.
Status indication at lower left in Flash Programming window is changed to "Connected" from "Connecting".
When it did not changed, check the connection of FPC or RS-232C cable.

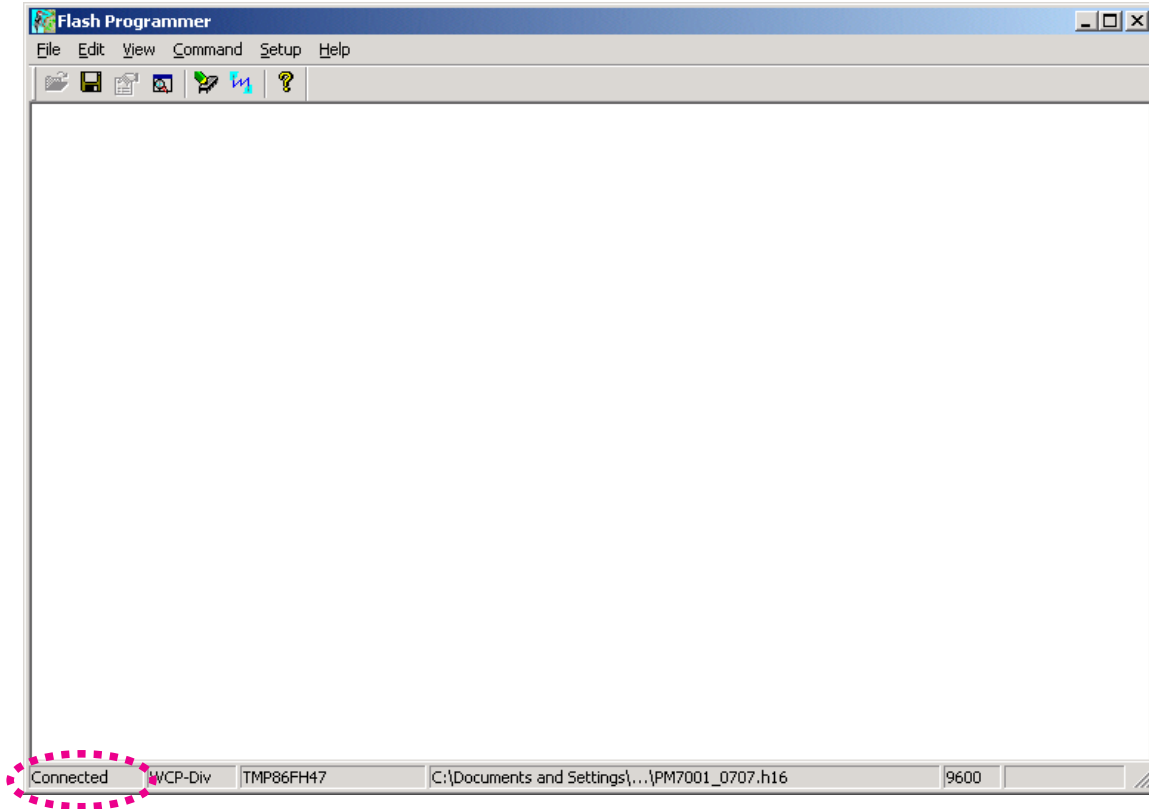

- (21) Select Password in Setup.

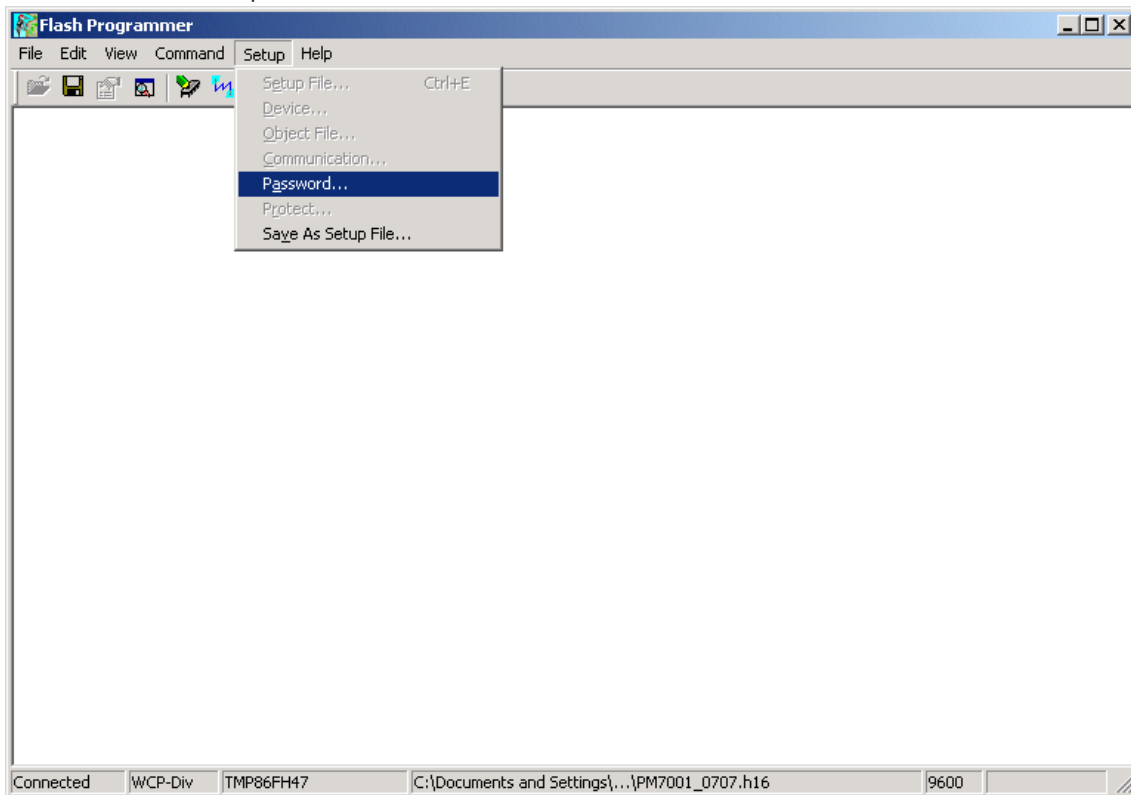

(22) Setup Password opens.

Setup Password

Address Mode

Single Chip Mode Single Boot Mode

Device Password

Device is BLANK

Input Type Ascii Hex

Password

Password Character Number Address

Password Compare Start Address

Object File Password

BLANK Password

Input Type Ascii Hex

Password

Password Character Number Address

Password Compare Start Address

- When writing in a blank microprocessor (Refer to next page).
- When writing (update) in the already written-in microprocessor (Refer to 00 page).

When writing in a blank microprocessor

Check Single Boot Mode in Address Mode.

Setting in Device Password

- Check Device is BLANK.
- Check Hex in input type.
- Since they are inputted automatically, please do not change text box of "Password", "Password Character Number Address" and "Password Compare Start Address".

Setting in Object File Password

- Do not check BLANK password.
- Check Hex in Input Type.
- Type 0102030405060708 into Password.
- Type 0xFF00 into Password Character Number Address.
- Type 0xFF01 into Password Compare Start Address.

Click OK.

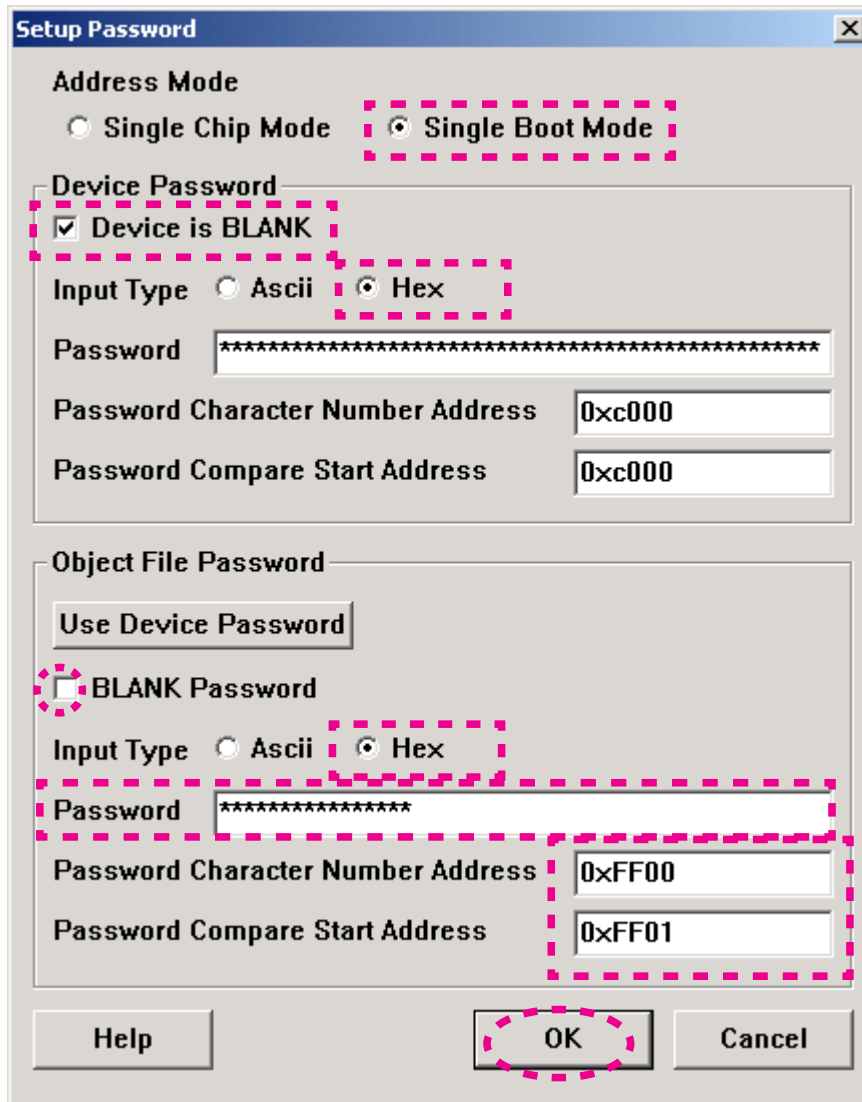

When writing in the already written-in microcomputer (update)

Check Single Boot Mode in Address Mode.

Setting in Device Password

- Check Device is BLANK.
- Check Hex in input type.
- Type 0102030405060708 into Password.
- Type 0xFF00 into Password Character Number Address.
- Type 0xFF01 into Password Compare Start Address.

Setting in Object File Password

- Do not check BLANK password.
- Check Hex in Input Type.
- Type 0102030405060708 into Password.
- Type 0xFF00 into Password Character Number Address.
- Type 0xFF01 into Password Compare Start Address.

Click OK.

Setup Password

Address Mode

Single Chip Mode Single Boot Mode

Device Password

Device is BLANK

Input Type Ascii Hex

Password *****

Password Character Number Address 0xFF00

Password Compare Start Address 0xFF01

Object File Password

Use Device Password

BLANK Password

Input Type Ascii Hex

Password *****

Password Character Number Address 0xFF00

Password Compare Start Address 0xFF01

Help **OK** Cancel

(23)Auto Programming opens.

Auto Programming

Flash Memory Programming

- All Erase
- Programming
- Verify with SUM
- File Compare

Recover Process by Programming Error

- Auto Retry Number times
- Manual

Execute Result

Complete: Recover Error:

Display Message

- Protect Check

Start **Cancel**

(24) Check All Erase, Programming, Verify with SUM and File Compare in Flash Memory Programming.
Check Manual in Recover Process by Programming Error.
Click Start.

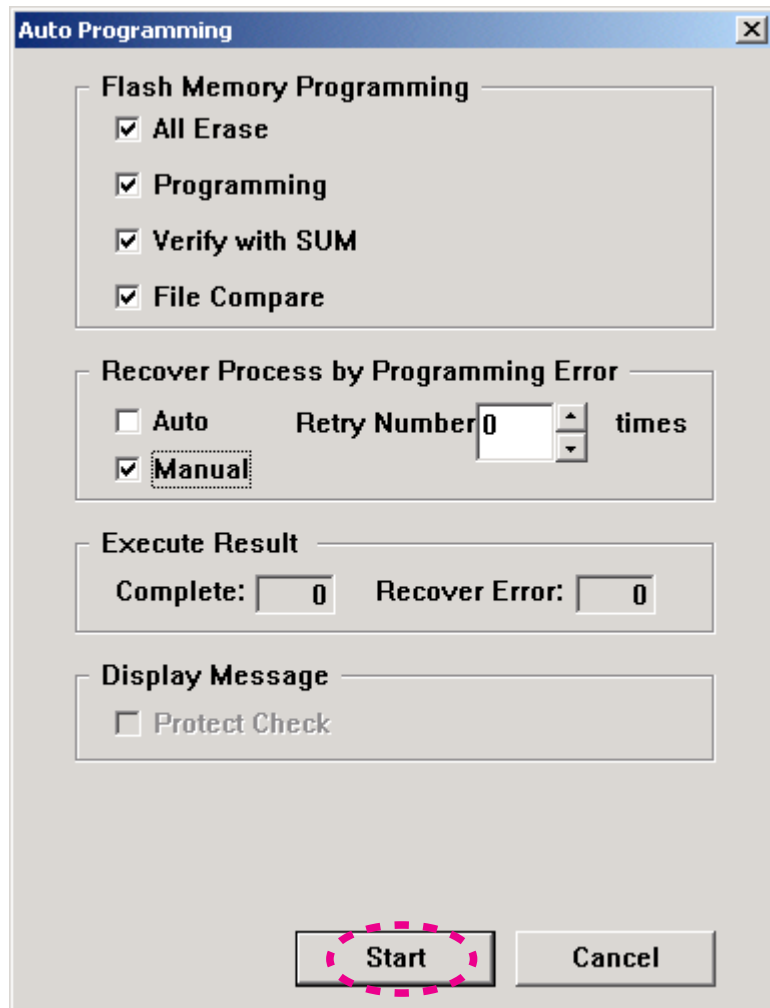

(25) Writing data is written into the microprocessor (U101).

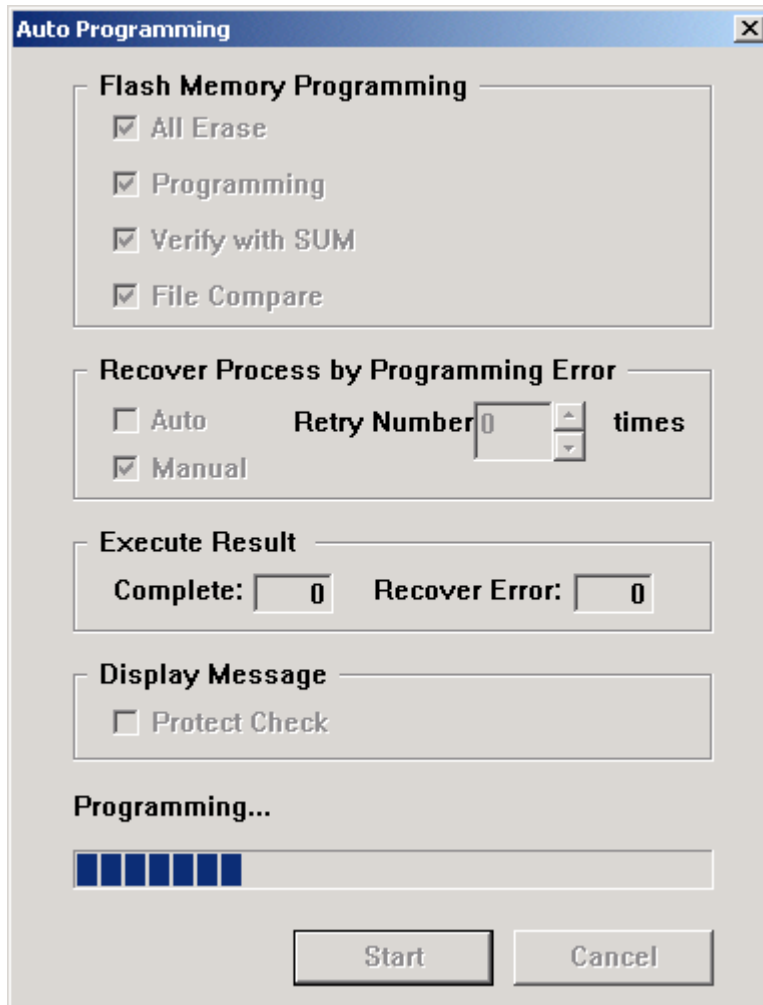

(26) Click Yes, when writing is successful.

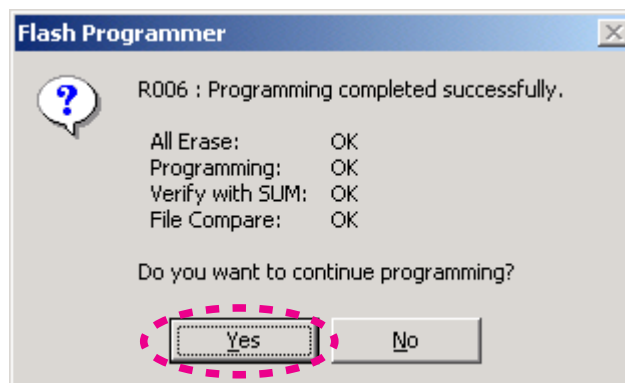

(27) Click Cancel.

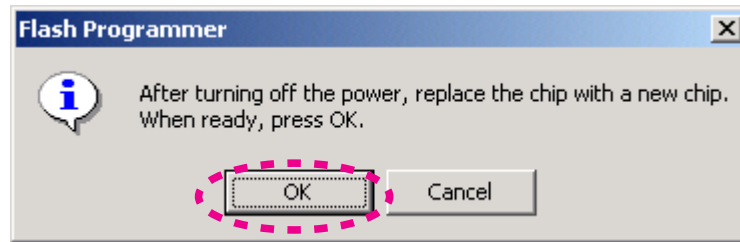

(28) Click Cancel.

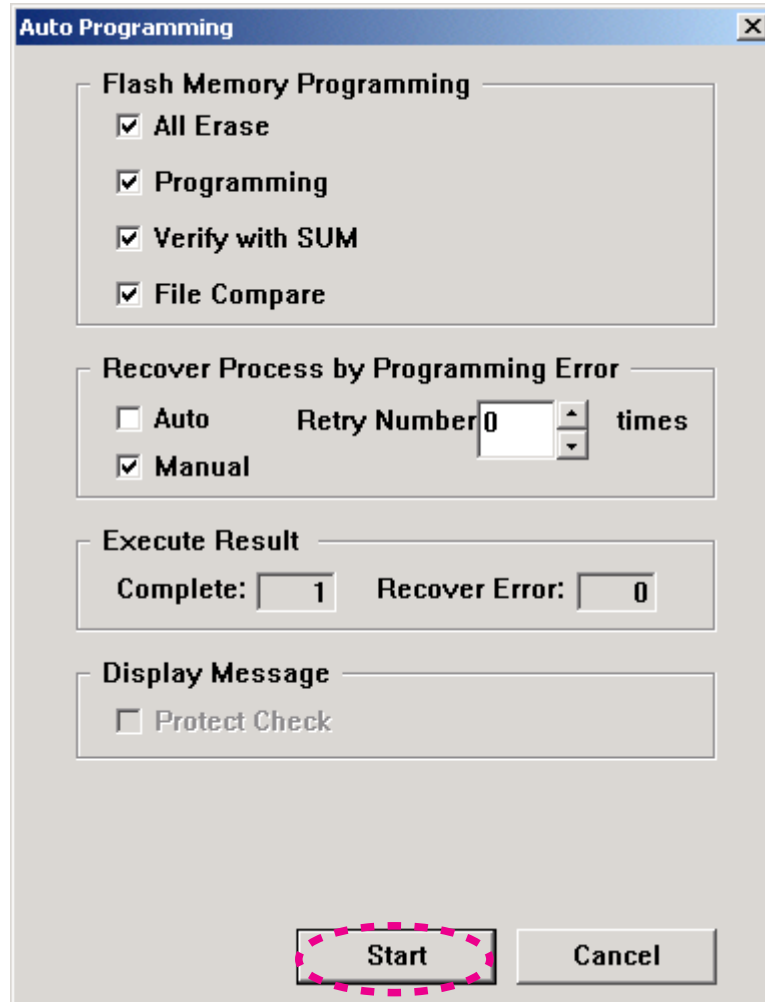

(29) Select the Exit in File, and finish.

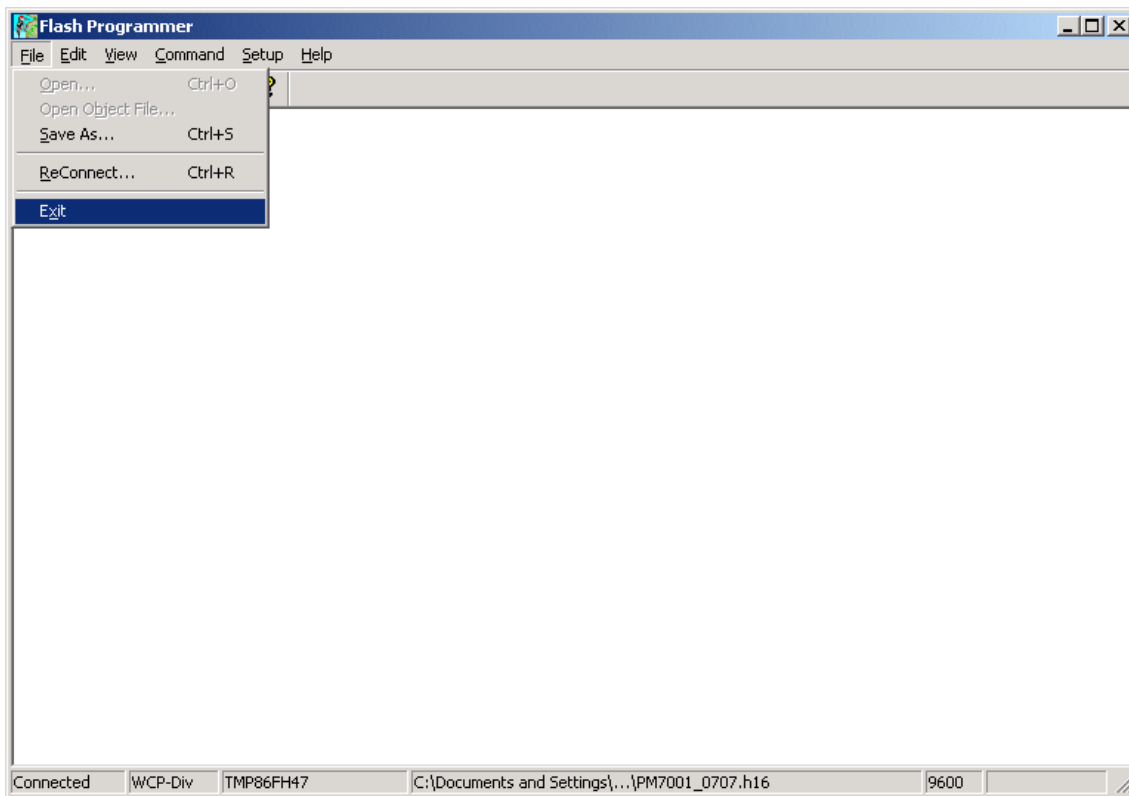

(30) Press the POWER ON/OFF button, and turn off the unit.
Disconnect each cable.

(31) Check the software version.
Refer to "3. SERVICE MODE" on page 4.

ADJUSTMENT

IDLING CURRENT ALIGNMENT

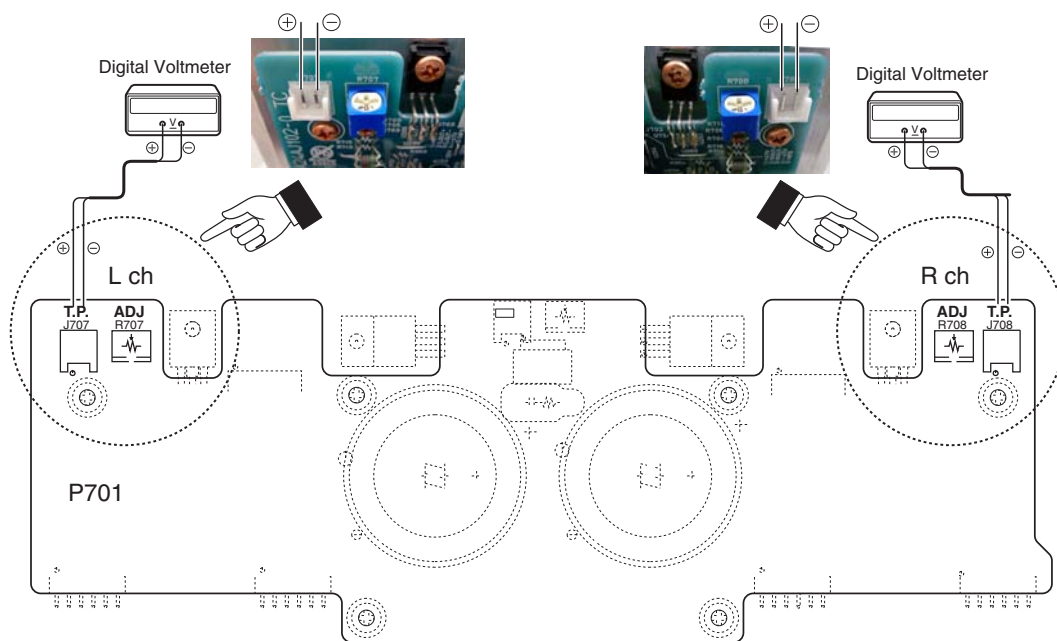

Adjustment Procedure

Set the power voltage to rated voltage for this adjustment.

- (1) Adjust the Idling Current with the variable resistor R707 and R708 on the PWB P701.
- (2) Turn off the power.
- (3) "+" of Connect Digital Voltage is connected to the No. 1 pin and connected "-" to No. 2 pin of J707.
- (4) "+" of Connect Digital Voltage is connected to the No. 1 pin and connected "-" to No. 2 pin of J708.
- (5) Before turning on the power, R707 and R708 have been counter clockwise turned with the adjustment driver.
- (6) Turn on the power, VOLUME is set as $-\infty$.
- (7) After 2 minutes.
With seeing the digital voltage meter turn the variable resister clockwise slowly to adjust the idling current.
Idling adjustment with R707 (R708).
 - Turn R707 (R708) clockwise to increase the idling current.
 - The adjustment value of idling current is $3 \text{ mV}(15 \text{ mA}) \pm 0.5 \text{ mV}(2.5 \text{ mA})$ each.
- (8) After 6 minutes.
Repeat the same procedure as 7.
 - The adjustment value of idling current is $12.5 \text{ mV}(62.5 \text{ mA}) \pm 0.5 \text{ mV}(2.5 \text{ mA})$ each.

Adjustment is completed.

- (9) Remove connection cable, attach the top cover.

NOTE : Idling current decreases with the temperature rise inside the unit, and it is set to $10 \text{ mV} (50 \text{ mA})$ of setting value in about 30 minutes after turn on the power.

DC Offset Voltage Adjustment

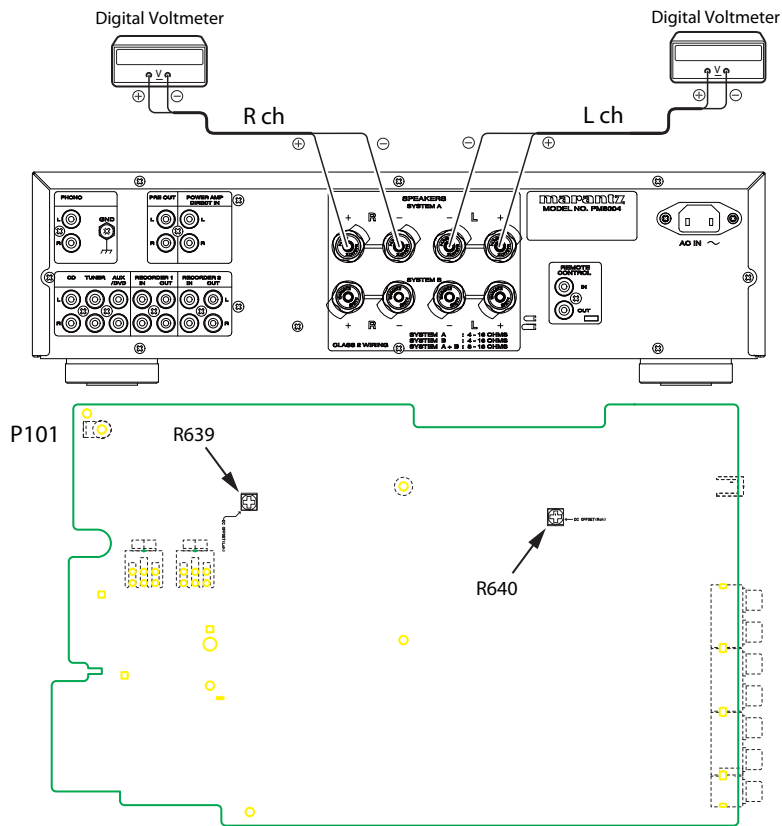

Adjustment Procedure

Set the power voltage to rated voltage for this adjustment.

- (1) Before turning on the power, Insert Digital Voltage Meter between the SPEAKERS SYSTEM A (L CH) "+" and "-". Insert Digital Voltage Meter between the SPEAKERS SYSTEM A (R CH) "+" and "-".
- (2) Adjust the VOLUME to MIN.
- (3) Turn on the power. Then turn the SPAKERS SW to A. Adjustment is started immediately after a speaker relay turns on.
- (4) First L CH is adjusted.
The variable resistor R639 on P101 is turned with adjustment driver, and the Digital Voltage Meter is adjusted to "0 mV \pm 3 mV".
- (5) Then, R CH is adjusted.
The variable resistor R640 on P101 is turned with adjustment driver, and the Digital Voltage Meter is adjusted to "0 mV \pm 3 mV".

NOTE : DC offset voltage drops when turn the semi-fixed resistor (R639 and R640) clockwise. DC offset voltage rises when turn the semi-fixed resistor un-clockwise. Please turn it slowly, because value of Digital Voltage Meter changes slowly.

- (6) Although after-adjustment DC offset voltage has some change, Please check that the range of DC offset voltage between L ch (R ch) "+" and L ch (R ch) "-" terminal of SPEAKERS SYSTEM A is "0 mV \pm 20 mV". CHART OF FACTORY MODE.

TROUBLE SHOOTING

1. The power can not be turned on. (STANDBY LED does not light (STANDBY MODE))

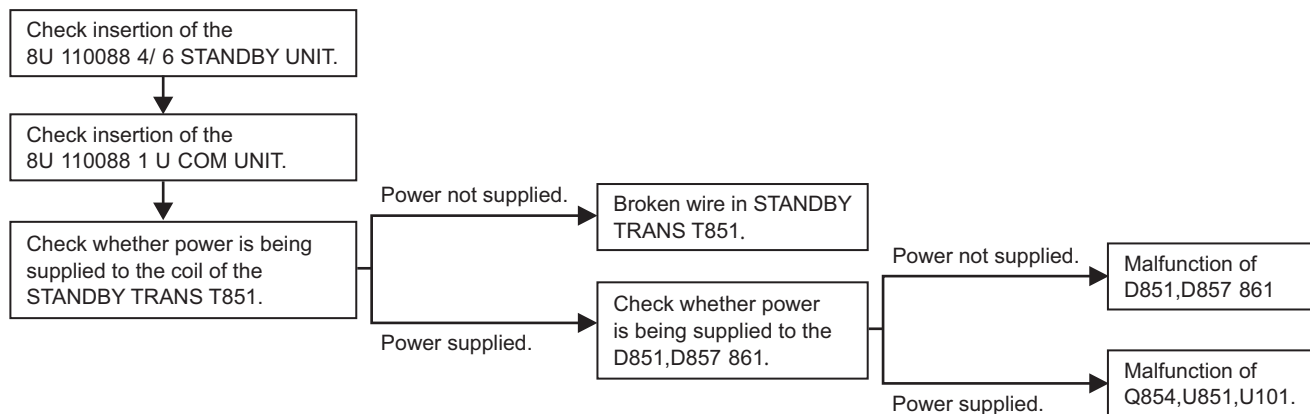

2. The power can not be turned on. (STANDBY LED lights→flash)

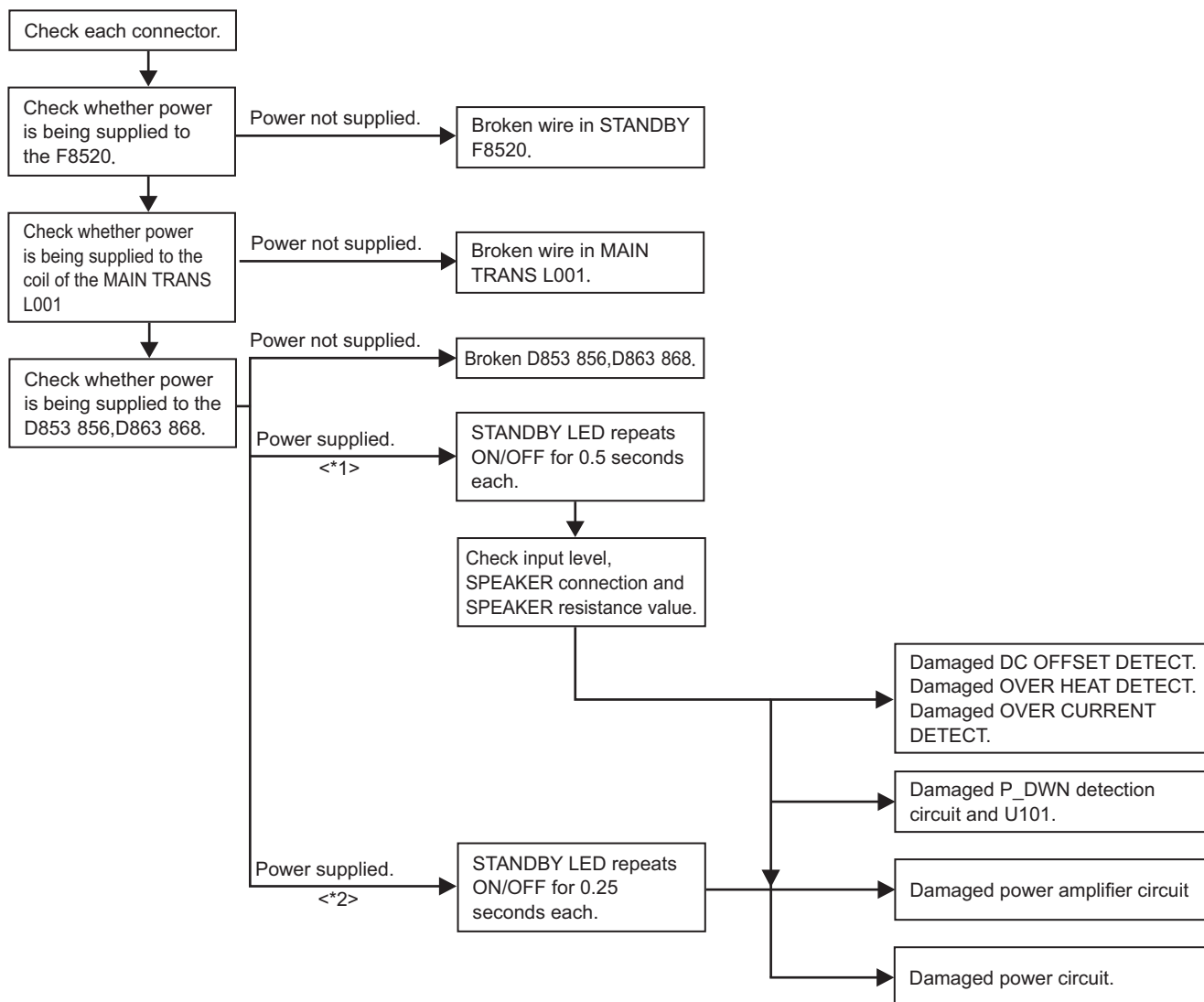

3. STANDBY LED flashes while using unit. (protection circuit is set)



4. The power turned on, but a sound does not output normally. (Both channels)

4.1 STANDBY LED does not flash (protection mode is not set)

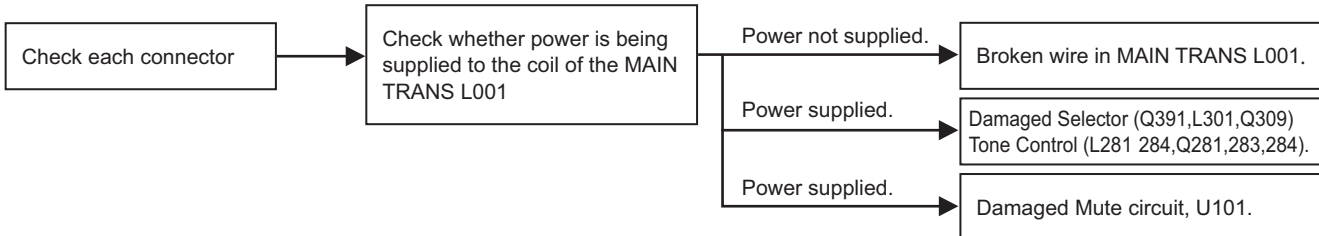

4.2 When the volume is turned up, Mute LED flashes. (protection mode is set)

Repeats ON/OFF for 0.5 second each, and automatically returns to normal operation.

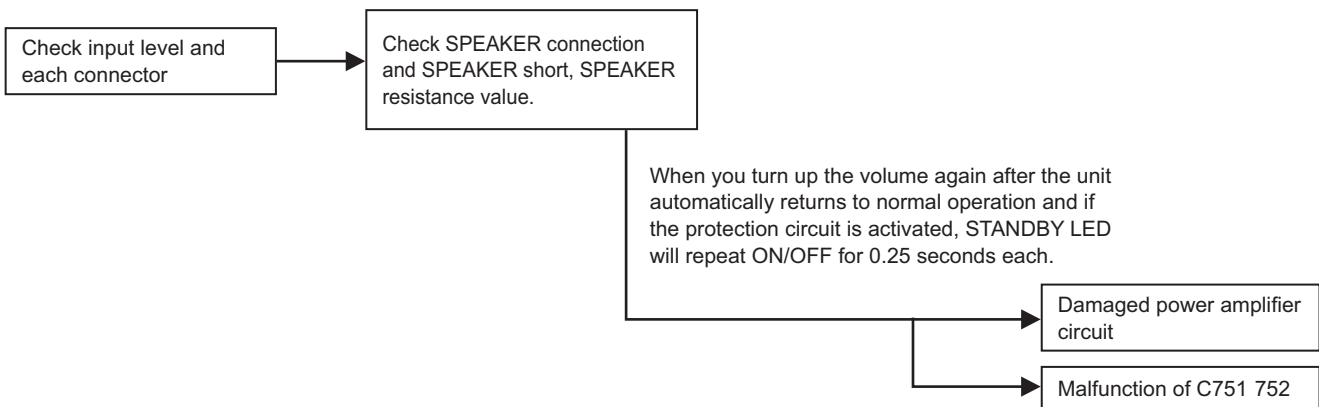

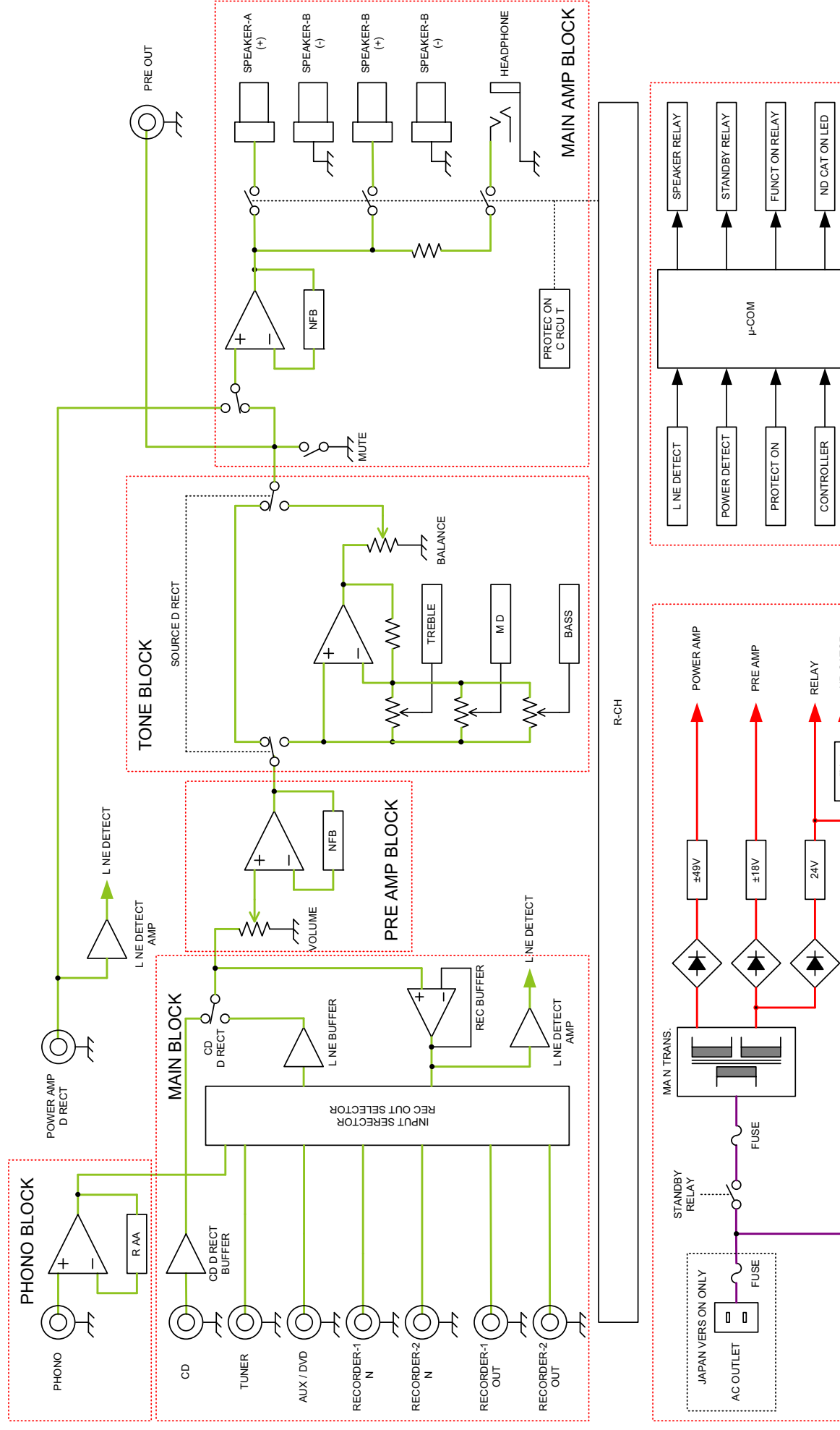
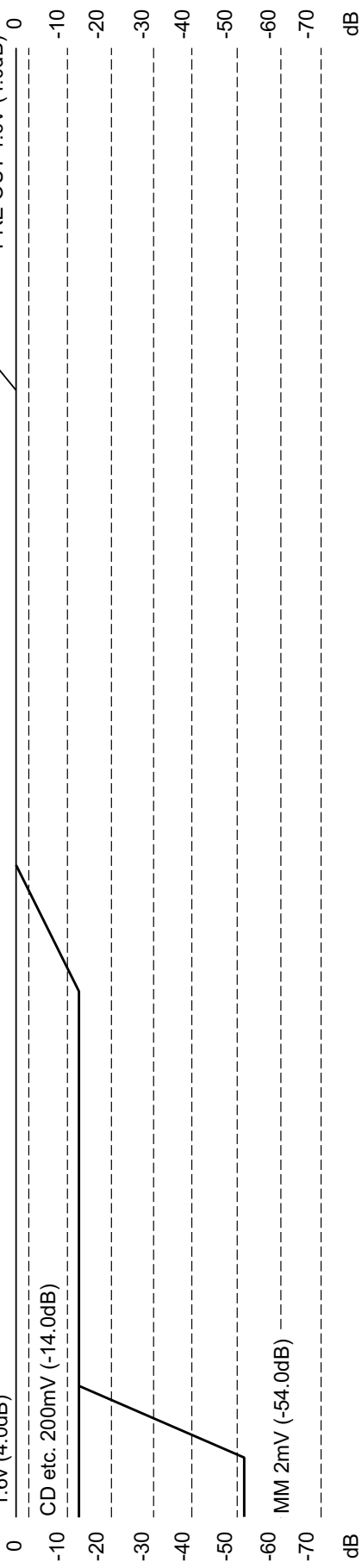

B C D E F G H I J

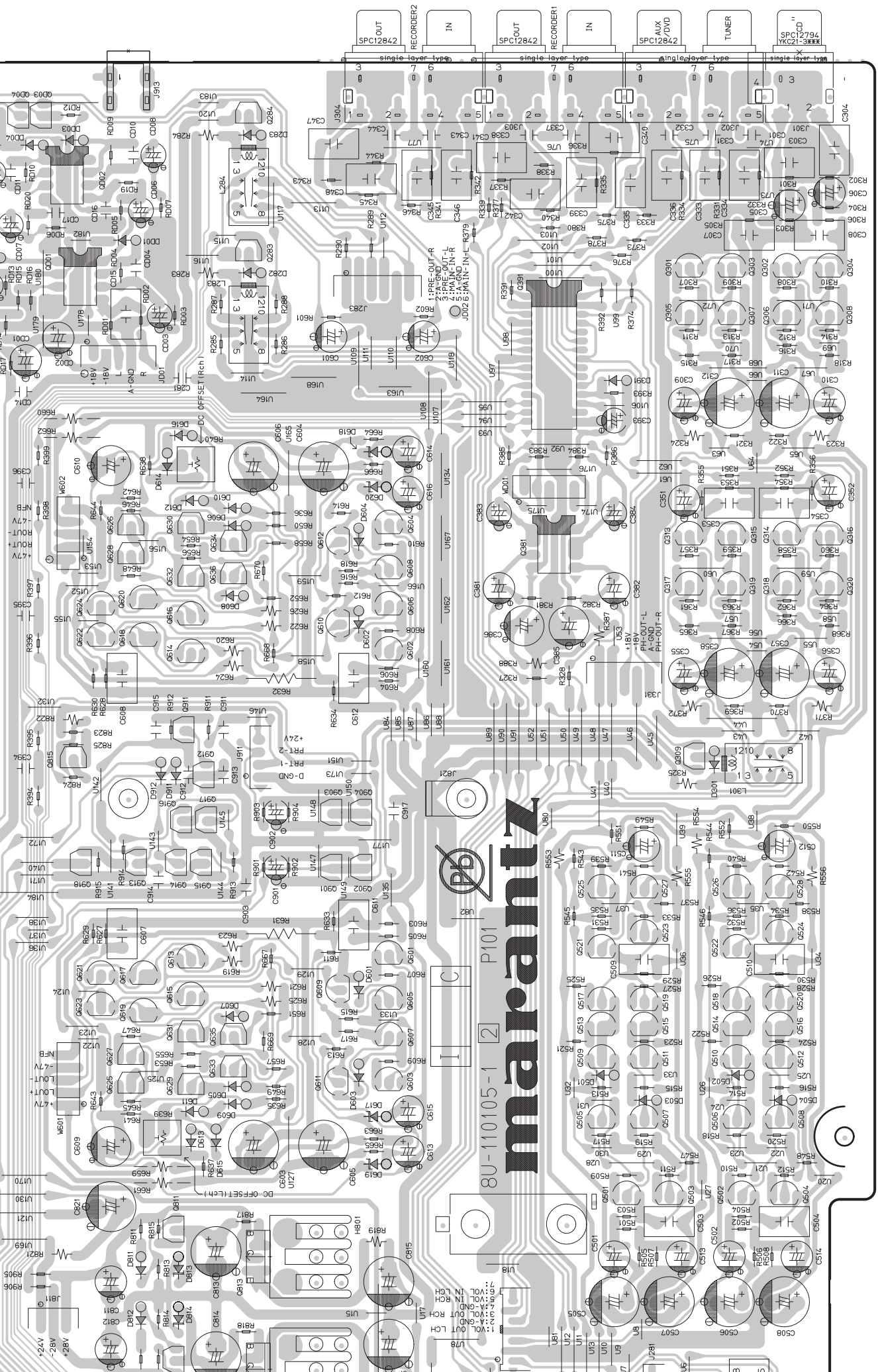

8U-110105-1 2 P101

marantz



C

I

C

C

C

C

C

C

C

C

C

C

C

C

C

C

C

C

C

C

C

C

C

C

C

C

C

C

C

C

C

C

C

C

C

C

C

C

C

C

C

C

C

C

C

C

C

C

C

C

C

C

C

C

C

C

C

C

C

C

C

C

C

C

C

C

C

C

C

C

C

C

C

C

C

C

C

C

C

C

C

C

C

C

C

C

C

C

C

C

C

C

C

C

C

C

C

C

C

C

C

C

C

C

C

C

C

C

C

C

C

C

C

C

C

C

C

C

C

C

C

C

C

C

C

C

C

C

C

C

C

C

C

C

C

C

C

C

C

C

C

C

C

C

C

C

C

C

C

C

C

C

C

C

C

C

C

C

C

C

C

C

C

C

C

C

C

C

C

C

C

C

C

C

C

C

C

C

C

C

C

C

C

C

C

C

C

C

C

C

C

C

C

C

C

C

C

C

C

C

C

C

C

C

C

C

C

C

C

C

C

C

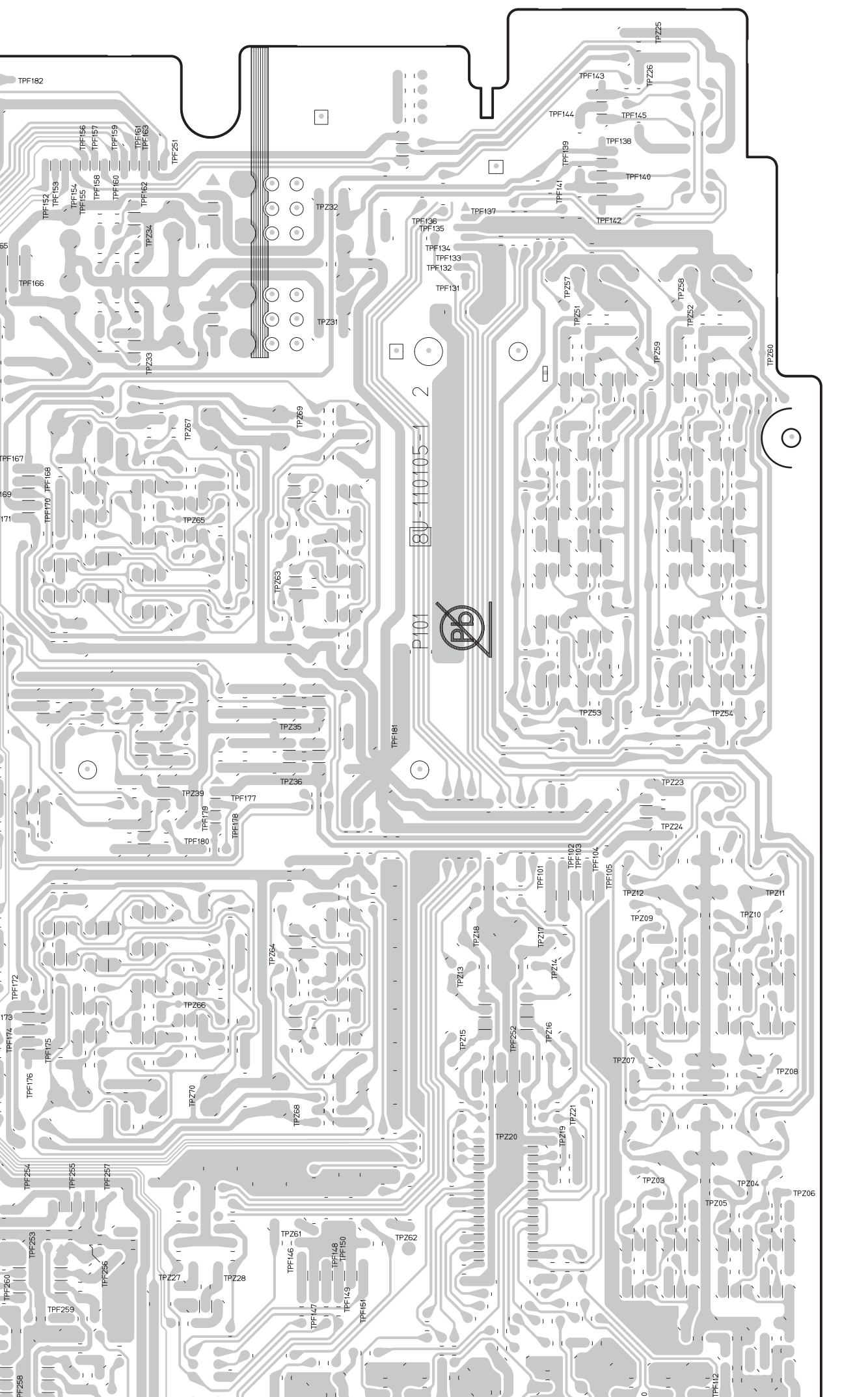

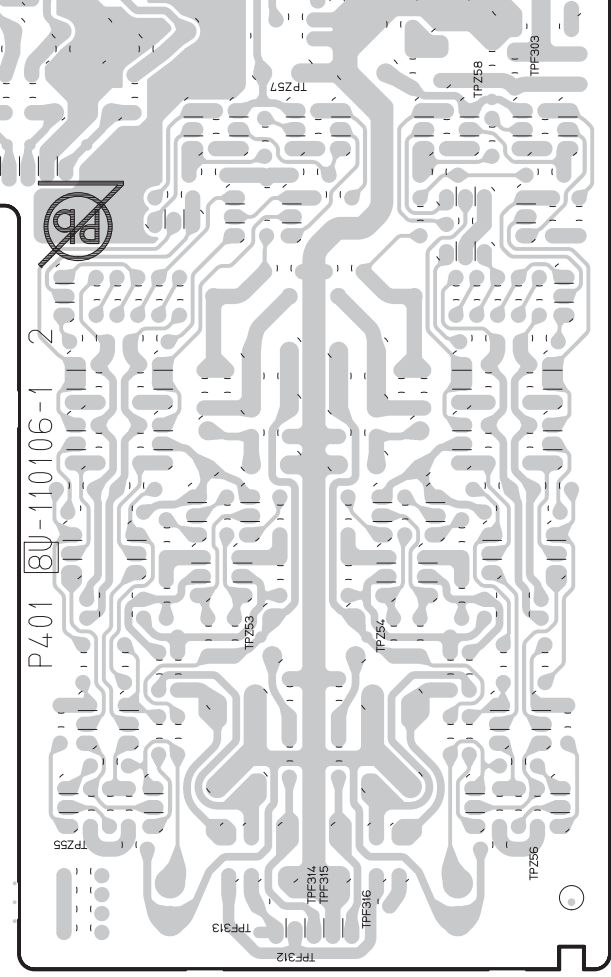
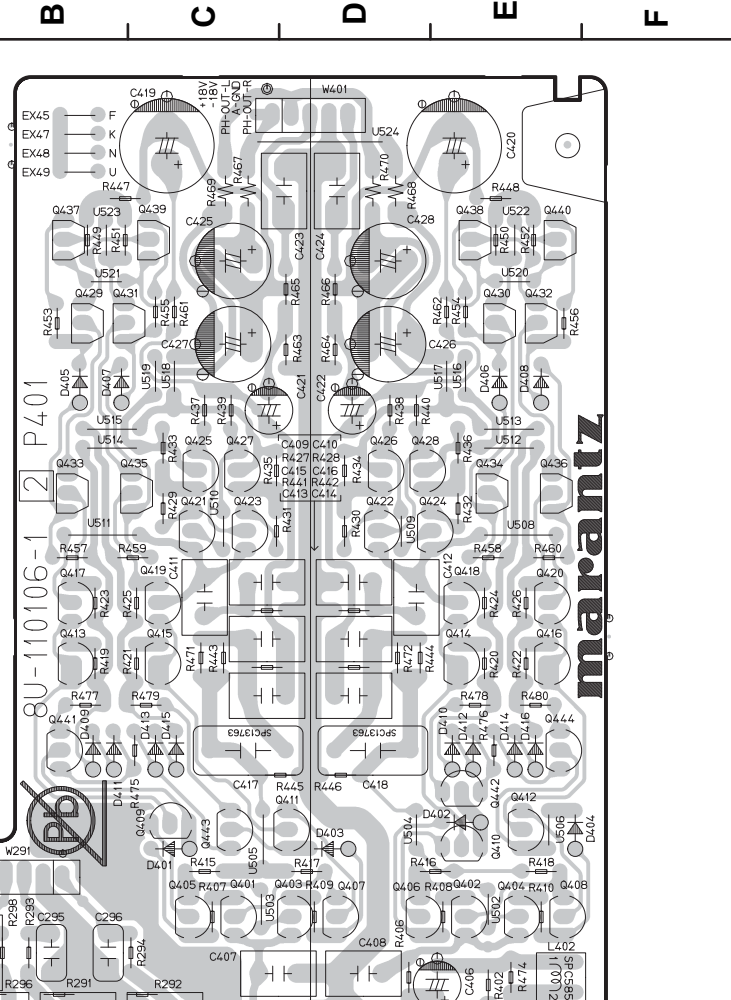

COMPONENT SIDE

POWER SW (FOIL SIDE)

SEL (FOIL SIDE)

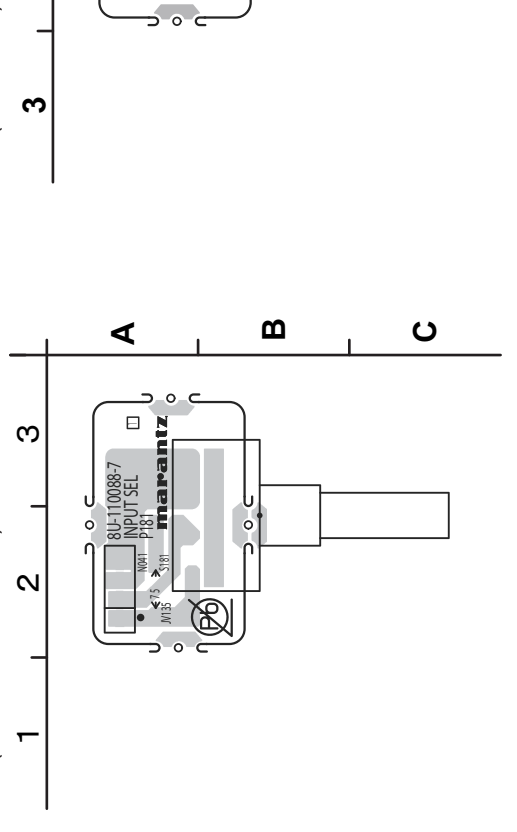
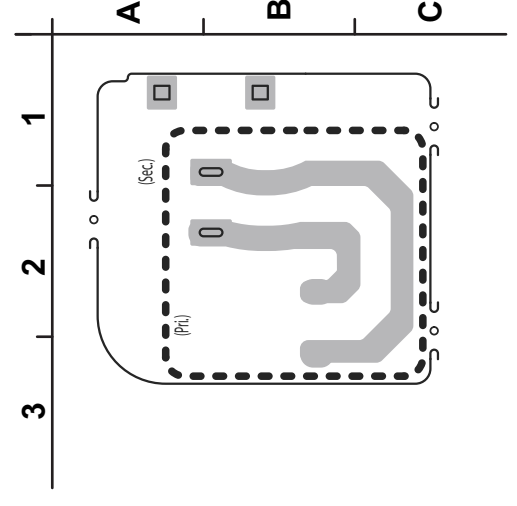
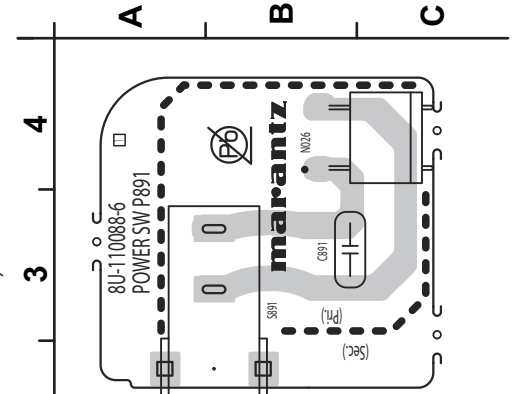

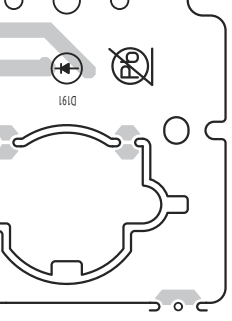

STANDBY LED (FOIL SIDE)

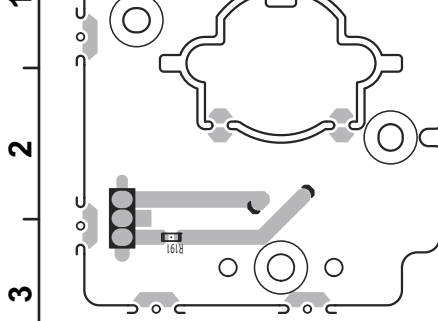

B C D E F G H I J K L

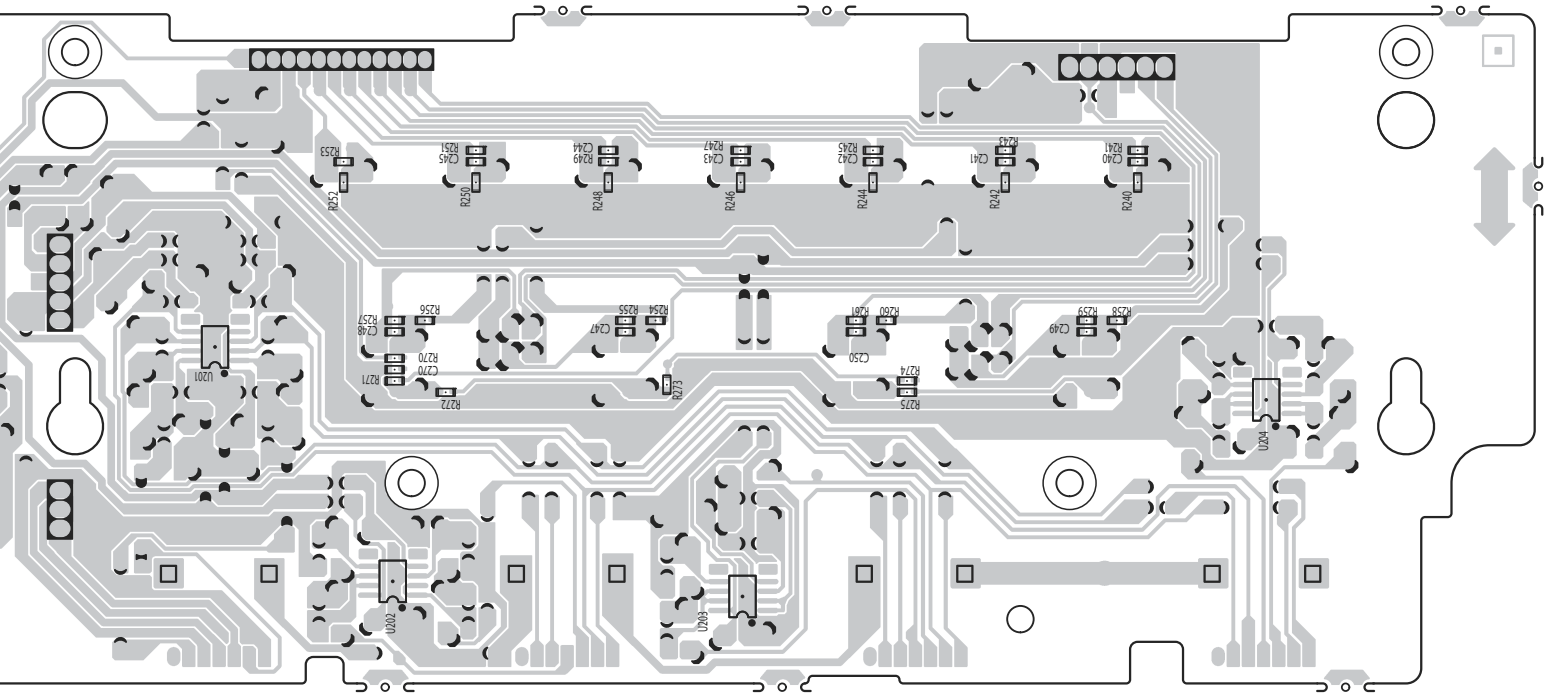

B C D E F G H I J K L

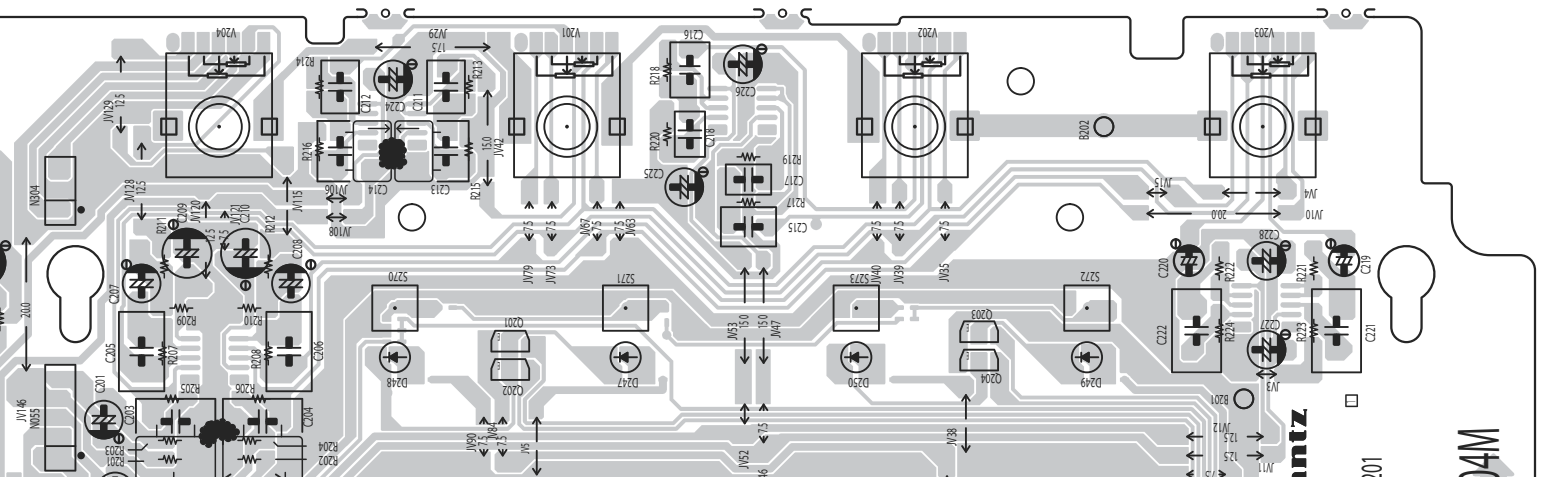

101
14M

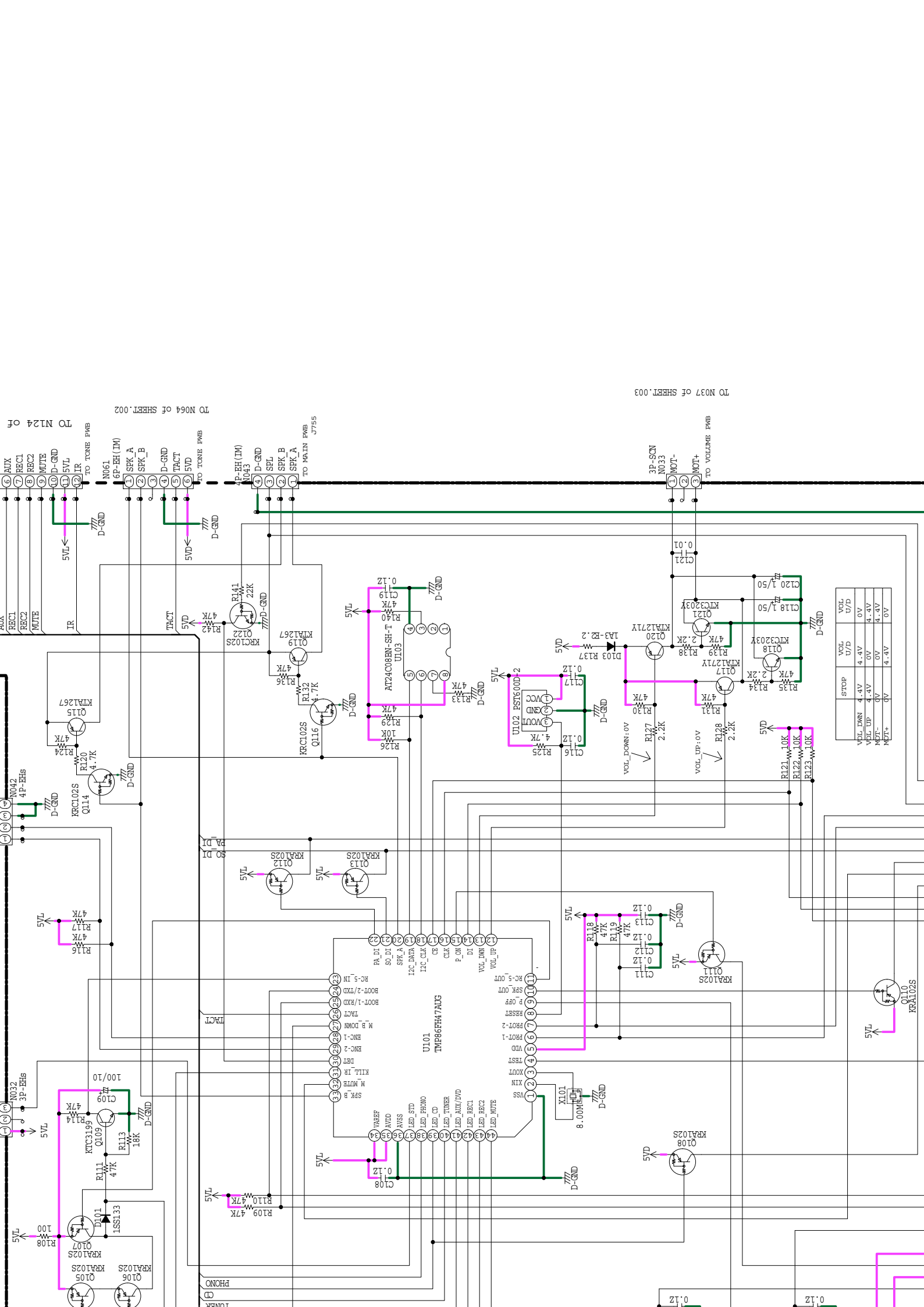

STOP	VOL	VOL	VOL
	U/D	U/D	U/D
VDL_DOWN	4.4V	4.4V	0V
VDL_UP	4.4V	4.4V	4.4V
MUTE	0V	0V	4.4V
MEV+	0V	4.4V	0V

TO N037 of SHEET.003

TO N064 of SHEET.002

TO N124 of

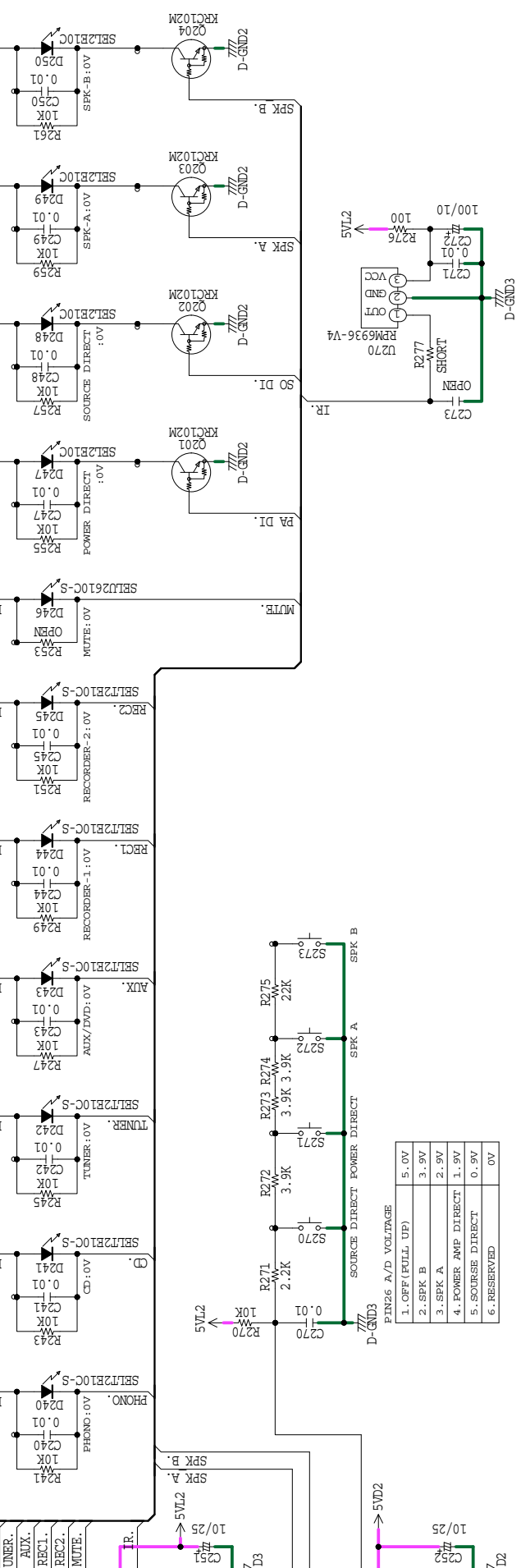

P201 8U-110088-2
TONE PWB

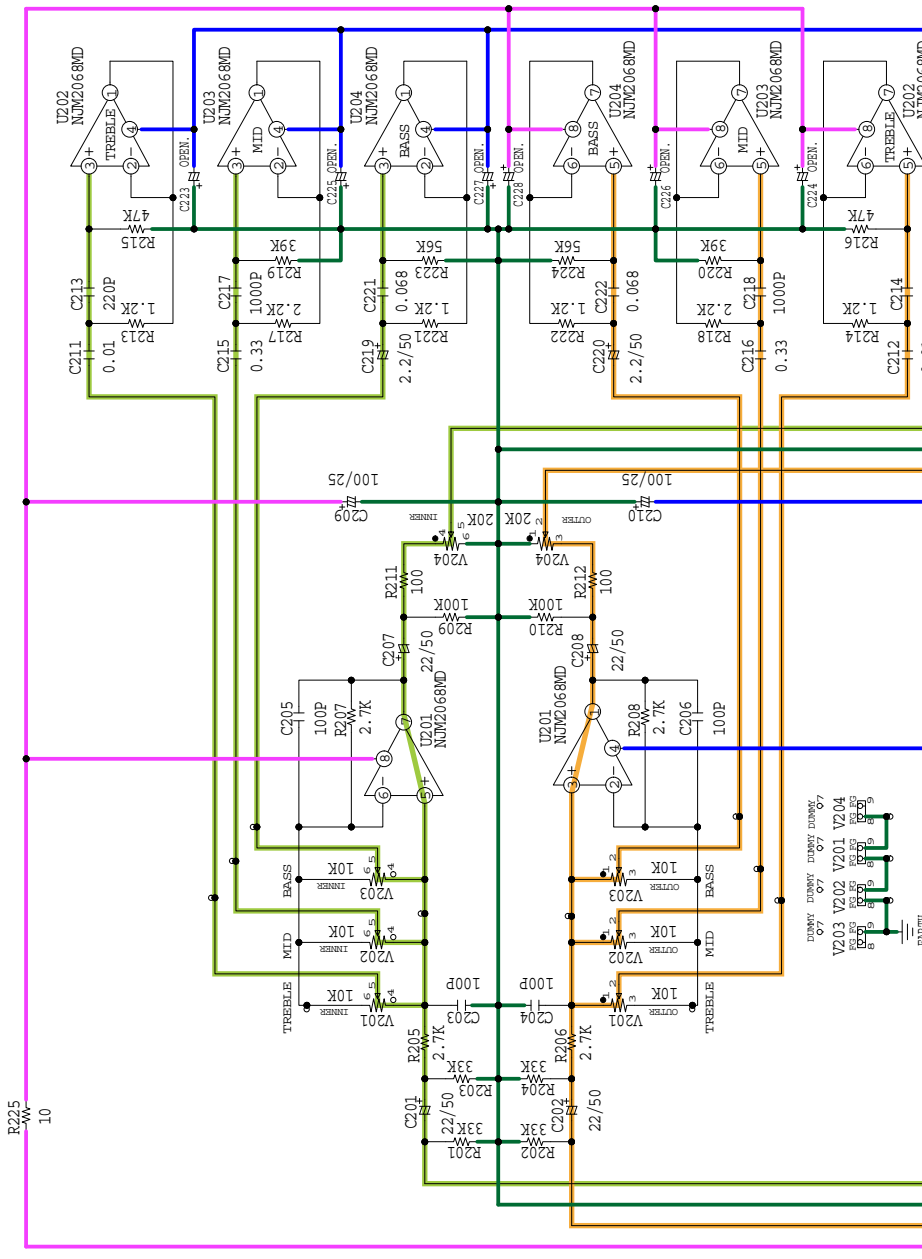

PIN26 A/D VOLTAGE

1. OFF (FULL UP)	5.0V
2. SPK B	3.9V
3. SPK A	2.9V
4. POWER AMP DIRECT	1.9V
5. SOURCE DIRECT	0.9V
6. RESERVED	0V

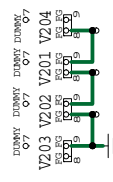

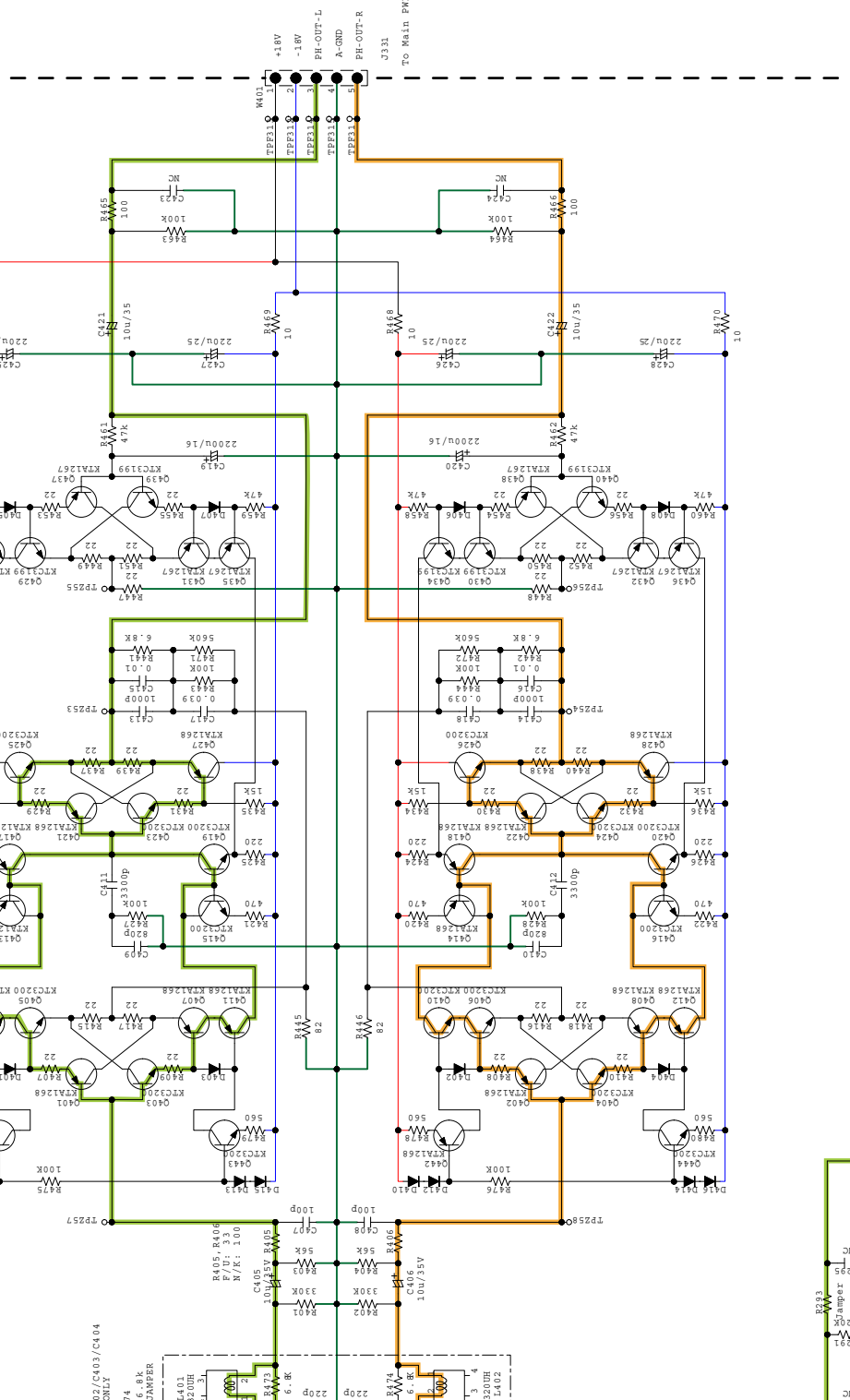
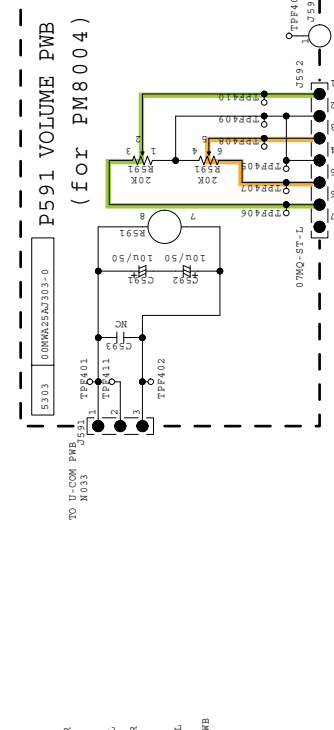
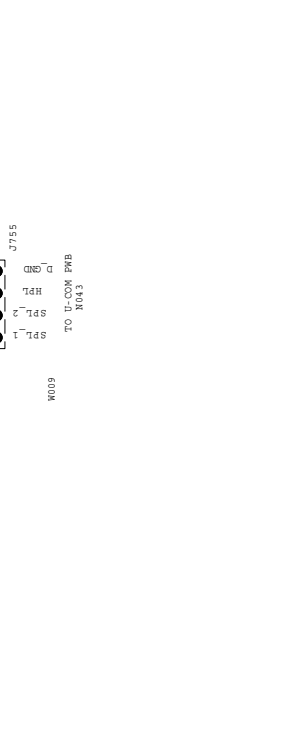
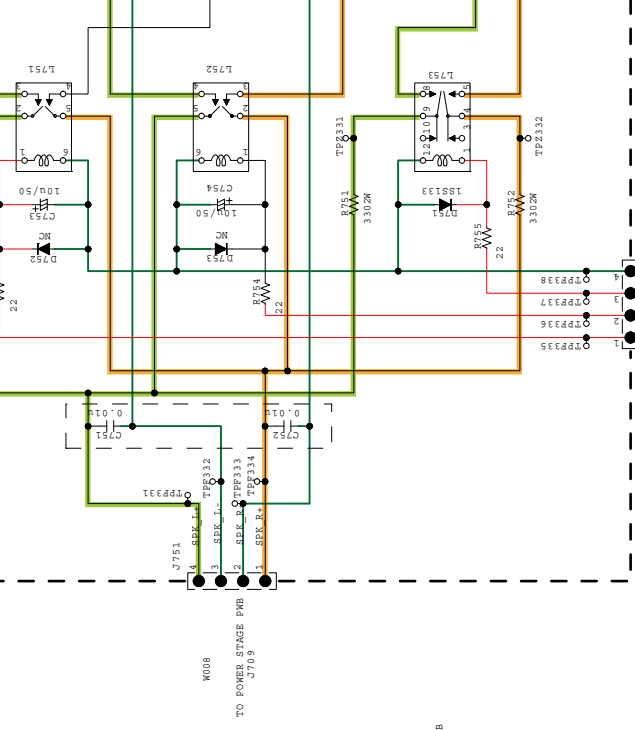

Part Name	Remarks	Qty	new
MAIN PWB ASSY (M01) FOR N K	N,K	1	
MAIN PWB ASSY (M01) FOR F U	U	1	
MAIN PWB(P101) UNIT			
WIRE PROTECTION PWB(P104) UNIT			
POWER STAGE PWB(P701) UNIT			
FRONT PWB ASSY (M02) FOR N K	N,K	1	
FRONT PWB ASSY (M02) FOR U	U	1	
SEL PWB(P181) UNIT			
STANDBY LED PWB(P191) UNIT			
STONE AMP PWB(P201) UNIT			
HEADPHONE PWB(P791) UNIT			
STANDBY PWB(P851) UNIT			
POWER SW PWB(P891)			
CLAMP PWB(P981) UNIT			
U-COM PWB(PU01) UNIT			
PHONO AMP PWB ASSY (M03) FOR N K	N,K	1	
PHONO AMP PWB ASSY (M03) FOR F U	U	1	
PHONO AMP PWB(P401) UNIT			
VOLUME PWB(P591) UNIT			
SPK TERMINAL PWB(P751)			
FRONT AL PANEL BL PM-K -PEARL-L TE A335	N1B	1	*
FRONT AL PANEL SG PM-K -PEARL-L TE A335	N1SG	1	*
FRONT AL PANEL BL PM8004 A335	U1B	1	*
FRONT AL PANEL SG PM8004 A335	K1SG	1	*
TOP COVER BL PM7003 24AJ	B	1	
TOP COVER SG PM7003 24AJ	SG	1	
CHASSIS	N,K	1	
CHASSIS	U	1	
MAIN HEATSINK		1	
MARANTZ BADGE (AL) FOR M1 MODEL		1	
SCREW STOPPER		1	
HEATSINK BRACKET		2	
ESCUICHEON CENTER PM7003 24AJ		1	
ESCUICHEON CENTER BASE BL PM7003 24AJ	B	1	
ESCUICHEON CENTER BASE SG PM7003 24AJ	SG	1	
SCREW		1	
BOTTOM LID PM8001(15AJ)	N	1	
BOTTOM LID PM8001(15AJ)	U,K	2	
SUPPORT PM7004 A334		6	*
LENS FUNCTION PM7003 24AJ		7	
FRONT CENTER MOLD BL PM7004 A334	B	1	*
FRONT CENTER MOLD SG PM7004 A334	SG	1	*
BUFFER TOP COVER INSIDE PM7003 24AJ		2	
RING VOLUME BL PM7003 24AJ	B	2	
RING VOLUME SG PM7003 24AJ	SG	2	
LEGS SL		4	
ESCUICHEON L BL PM7004 A334	B	1	*
ESCUICHEON L SG PM7004 A334	SG	1	*
LENS		1	
BUTTON PUSH BL PM7003 24AJ	B	1	
BUTTON PUSH SG PM7003 24AJ	SG	1	
PCB SUPPORT PLUG		1	

Part Name	Remarks	Qty	new
LENS IR BL PM7003 24AJ	B		
LENS IR WH PM7003 24AJ	SG		
BUTTON BL PM7003 24AJ	B		
BUTTON SG PM7003 24AJ	SG		
TOP COVER SHEET			
SPECIAL SCREW			
SIDE RETAINER L PM7003 24AJ			
SIDE RETAINER R PM7003 24AJ			
BRACKET SA7003 33AK			
CONTACTOR PM7003 24AJ			
SIDE WOOD 110MM WS1101	N2		
REAR PANEL PM8004 (N) A335	N		
REAR PANEL PM8004 (U) A335	U		
REAR PANEL PM8004 (K) A335	K		
SPEAKER NUT			
SP SPACER			
SPEAKER PCB STUD			
AC INLET (2P)			
TERMINAL			
SPKT-1 RED			
SPKT-1 WHITE			
POWER TRANSFORMER 230V	N,K		
#POWER TRANSFORMER FOR 120V	U		
WIRE CLAMPER			
WIRE CLAMPER			
P.V.C. TUBE(L=20)	U		
P.V.C. TUBE(L=20)	U		
SUMITUBE_F(Z)_3X0.25_L=1000MM	U		
IFRH10A15			
IFCH10A15			
FERRITE CORE TFCK-16813			
TRANS STOR C3419 Y 40V 0.8A PC=1.2W (5W)			
2SC2837			
2SC2837			
2SA1186-Y/P-LF101			
2SA1186-Y/P-LF101			
PTH9M04BC222TS2F333			
PTH9M04BC222TS2F333	U		
★ W002	nsp		
★ W003	nsp		
★ W005	nsp		
★ W007	nsp		
★ W008	nsp		
★ W011	nsp		
★ WA01	nsp		
VAR-NO CN7 92MMP CHIP N BR,2P N BL10CM			
VAR-VAR 7 92MMP CH 1P N BR,2P N BR22CM			
PH-PH 13PIN L=14CM			
PHR-PHR 2.0MMPICH 10PIN 50CM			
VHR-VHR(NTYPE)3.96MM 4PIN 19CM			
PHR-PHR 2.0MMPICH 12PIN 14CM			
EHR3 EHR4 CORD ASSY			
WIRES			
★ Q703,704	00MHT334191Y0		
★ Q713	00MHT328372A0		
★ Q714	00MHT328372A0		
★ Q715	00MHT111862A0		
★ Q716	00MHT111862A0		
★ R969	00D2790034054		
★ R969,970	00D2790034054		
★ L002	nsp		
★ J003-J006	646710024006M		
J007-J010	646710025009M		
L001	1010100030088		
L001	101010024005M		
★ 048G	nsp		
★ 801G	nsp		
★ 969K	nsp		
★ 970K	nsp		
★ 971K	nsp		
★ D801	00MHE10004100		
★ D802	00MHE10003100		
★ L002	nsp		
★ Q703,704	00MHT334191Y0		
★ Q713	00MHT328372A0		
★ Q714	00MHT328372A0		
★ Q715	00MHT111862A0		
★ Q716	00MHT111862A0		
★ R969	00D2790034054		
★ R969,970	00D2790034054		
★ W002	nsp		
★ W003	nsp		
★ W005	nsp		
★ W007	nsp		
★ W008	nsp		
★ W011	nsp		
★ WA01	nsp		
VAR-NO CN7 92MMP CHIP N BR,2P N BL10CM			
VAR-VAR 7 92MMP CH 1P N BR,2P N BR22CM			
PH-PH 13PIN L=14CM			
PHR-PHR 2.0MMPICH 10PIN 50CM			
VHR-VHR(NTYPE)3.96MM 4PIN 19CM			
PHR-PHR 2.0MMPICH 12PIN 14CM			
EHR3 EHR4 CORD ASSY			

PACKING VIEW

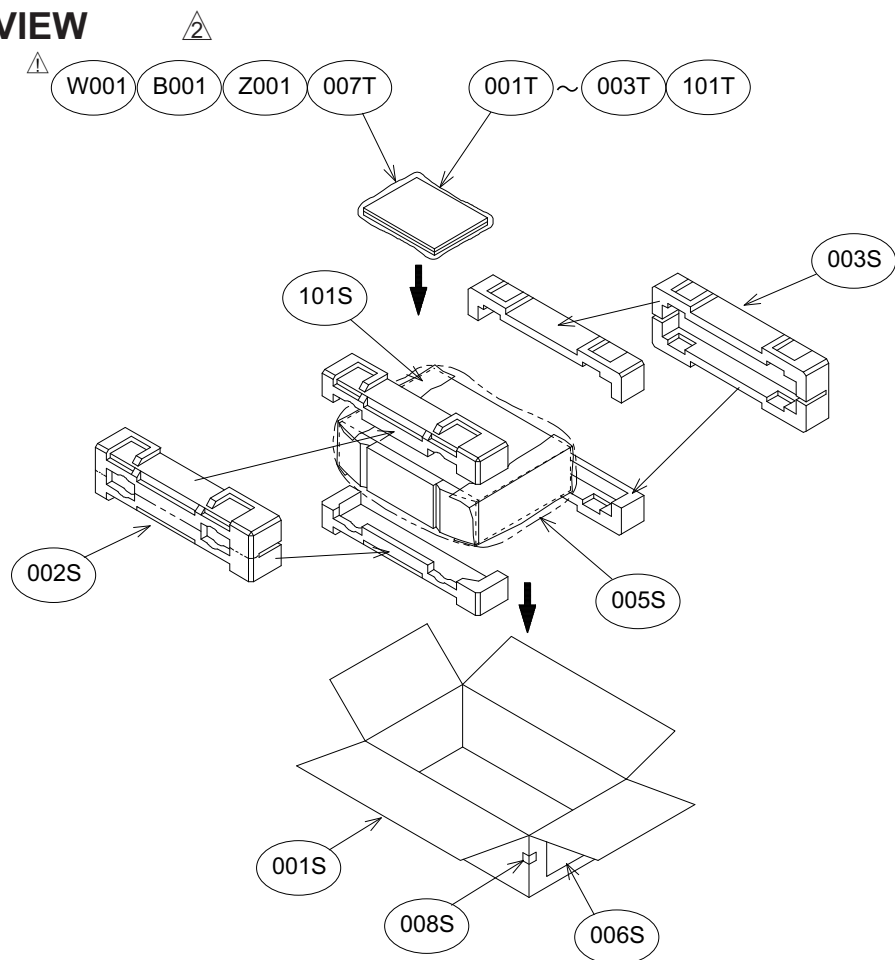

PARTS LIST OF PACKING VIEW

* Parts for which "nsp" is indicated on this table cannot be supplied.

* The parts listed below are for maintenance only, might differ from the parts used in the unit in appearances or dimensions.

Note: The symbols in the column "Remarks" indicate the following destinations.

U : North America model
B : Black model

N : Europe model
SG : Silver Gold model

K : China model

Ref. No.	Part No.	Part Name	Remarks	Q'ty	New
	001S	531210141004M	PACKING CASE PM KI PEARL LITE A335	N	1 *
	001S	531210140001M	PACKING CASE PM8004 A335	U,K	1 *
	001T	541110491035M	USER MANUAL PM7004/PM8004 (N) A335	N	1 *
	001T	541110491028M	USER MANUAL PM8004 (U) A335	U	1 *
	001T	541110491059M	USER MANUAL PM7004/PM8004 (K) A335	K	1 *
	002S	533510071108M	CUSHION SA8004 FRONT	N1,U,K	1 *
	002S	533610091002M	CUSHION FRONT M1 SIDE WOOD	N2	1 *
	003S	533510071115M	CUSHION SA8004 REAR	N1,U,K	1 *
	003S	533610092005M	CUSHION REAR M1 SIDE WOOD	N2	1 *
	002T	nsp	WARRANTY USA	U	1
	003T	nsp	WARRANTY CANADA	U	1
	005S	nsp	SHEET (AF+PE)		1
	006S	nsp	CONT.LABEL BASE(D&M)		1
	007T	nsp	POLYETHY BAG		1
	008S	nsp	LABEL FOR PKG SG	SG	2
	101S	nsp	UNWOVEN CLOTH(W490xL230)	N2	2
	101T	nsp	FLY SHEET SIDE WOOD PMKIPEARLLITE	N2	1 *
	B001	nsp	BATTERY(R03X2)		1
⚠	W001	00MZC01803080	# 2P AC CORD 10A 250V CLASS2	N	1
⚠	W001	00MZC01803100	# AC CORD UL/CSA 10A 125V	U	1
⚠	W001	00D2062249001	AC CORD (E1C)	K	1
	Z001	307010030006M	RC003PM		1

SEMICONDUCTORS

Only major semiconductors are shown, general semiconductors etc. are omitted to list.
 The semiconductor which described a detailed drawing in a schematic diagram are omitted to list.

1. IC's

TMP86FH47UG (U101)

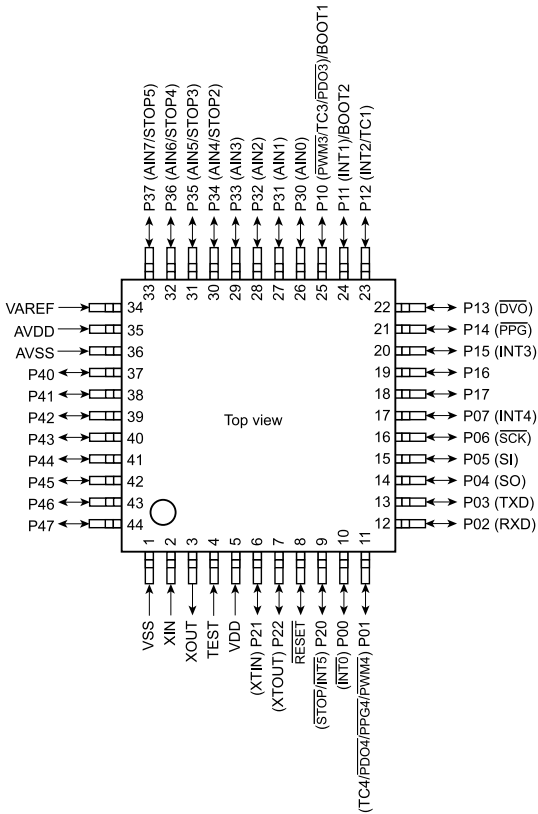

Block Diagram

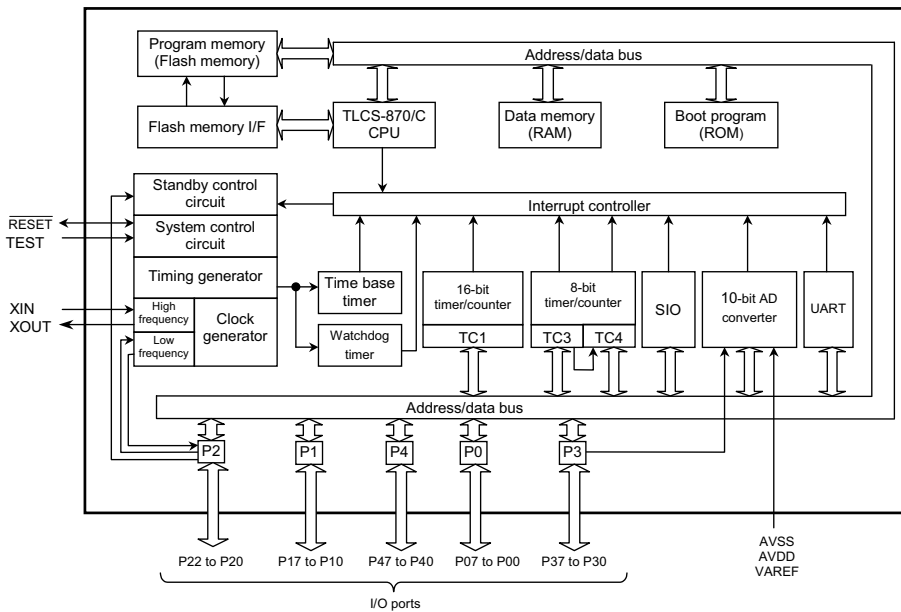

Terminal Function

Pin	Port Name	I/O	Use	Name	Port Setting				Note
					ACT	INIT	STBY	EXT.R	
1	VSS								0 V
2	XIN								8M Clock in
3	XOUT								8M Clock out
4	TEST	I	I		H		L	47k	L >H : PROM Mode(Program rewriting)
5	VDD			VDD					u com power supply 5V
6	P21 (XTIN)	I/O	I	PROT 1	L		H	47k	PROTECT_1: DC Offset / Over Current / Over Current
7	P22 (XTOUT)	I/O	I	PROT 2	L		H	47k	PROTECT_2:Voltage Abnormal Detect
8	RESET	I/O	I		L		H	4.7k	u com Reset connector
9	P20 (STOP/INT5)	I/O	I	P_OFF	L		H	47k	Detect Power Down(primary power supply ON/OFF detection). Oveserve at power supply cutting, Interrupt input
10	P00 (INT0)	I/O	O	SPK_OUT	L	H	H		Speaker Relay On (Audio Out)
11	P01 (TC4/PD04/PPG4/PWM4)	I/O	O	RC 5_OUT	L	H	H		RC 5 Output
12	P02 (RXD)	I/O	O	VOL_UP	L	H	H	47K	Volume up
13	P03 (TXD)	I/O	O	VOL_DWN	L	H	H	47K	Volume down
14	P04 (SO)	I/O	O	DI		L	L	10K	Data (LC78212)
15	P05 (SI)	I/O	O	P_ON	L	H	H		Primary Relay ON
16	P06 (SCK)	I/O	O	CLK			L	10K	Clock (LC78212)
17	P07 (INT4)	I/O	O	CE	H	L	L	10K	CE (LC78212)
18	P17	I/O	O	I2C_CLK		H	H	47k	I2C (EEPROM) (Pull up)
19	P16	I/O	I/O	I2C_DATA		H	H	10K	I2C (EEPROM) (Pull up)
20	P15 (INT3)	I/O	O	SPK_A	H	L	L		Speaker A Relay On
21	P14 (PPG)	I/O	O	SD_DI	L	H	H		Relay operation port on power amp direct source direct mode
22	P13 (DVO)	I/O	O	PA_DI	L	H	H		Relay operation port on power amp direct
23	P12 (INT2/TC1)	I/O	I	RC 5_IN	L		H	47k	RC 5 Input
24	P11 (INT1)(BOOT2)	I/O	I	BOOT 2/ TXD				47k	Pull Up
25	P10(PWM3/TC3/PD03) (BOOT1)	I/O	I	BOOT 1/ RXD				47k	Pull Up
26	P30 (AIN0)	I/O	I (AD)	TACT				10K	Source Direct / Power Amp Direct SW /SPK A / SPK B
27	P31 (AIN1)	I/O	I	M_B_DOWN	L		H	47k	Checking port for amp power supply off confirm
28	P32 (AIN2)	I/O	I	ENC_1	L		H	47k	Input Sel. Rotary Enc.
29	P33 (AIN3)	I/O	I	ENC_2	L		H	47k	Input Sel. Rotary Enc.
30	P34 (AIN4/STOP2)	I/O	I	DET	L		L	47k	Power down : L (for Signal detection circuit)
31	P35 (AIN5/STOP3)	I/O	O	KILL IR	H	L	L		RC 5 Kill
32	P36 (AIN6/STOP4)	I/O	O	M_MUTE	L	H	L		Manual Mute (Mute on :L)
33	P37 (AIN7/STOP5)	I/O	O	SPK_B	H	L	L		Speaker B Relay On
34	VAREF			VAREF					A/D Reference
35	AVDD			AVDD					5 V
36	AVSS			AVSS					0 V
37	P40	I/O	O	LED_STD	L	H	L		STANDBY LED/Protecting warning flushes
38	P41	I/O	O	LED_PHONO	L	H	H		PHONO LED
39	P42	I/O	O	LED_CD	L	H	H		CD LED
40	P43	I/O	O	LED_TUNER	L	H	H		TUNER LED
41	P44	I/O	O	LED_AUX/ DVD	L	H	H		AUX/DVD LED
42	P45	I/O	O	LED_REC1	L	H	H		REC1 LED
43	P46	I/O	O	LED_REC2	L	H	H		REC2 LED
44	P47	I/O	O	LED MUTE	L	H	H		MUTE LED/Protecting1 warning flushes

LC78212 (Q391)

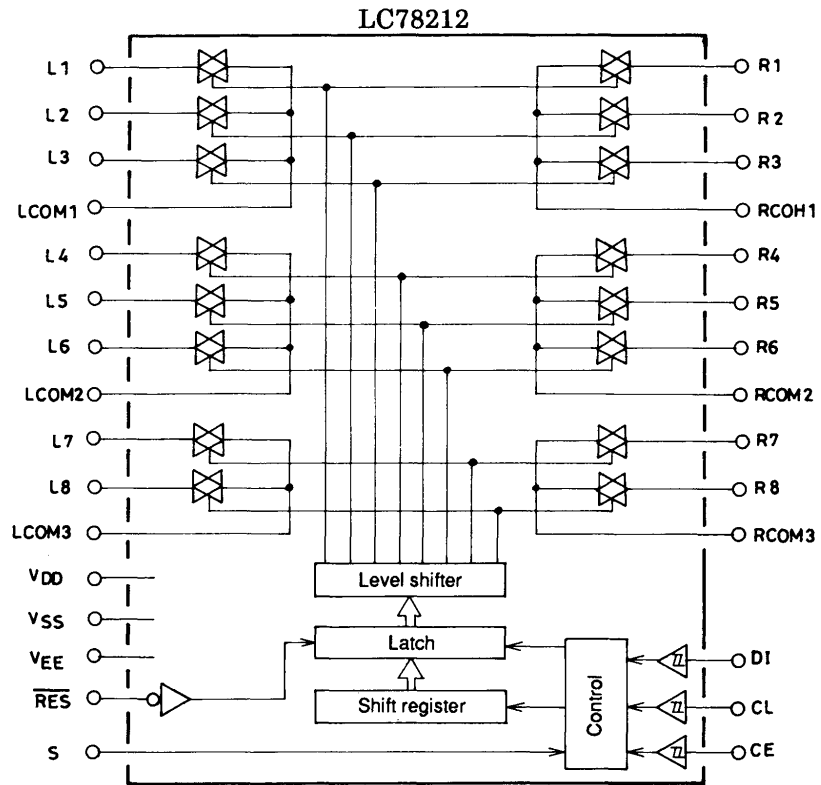

PARTS LIST OF P.C.B. UNIT

* Parts for which "nsp" is indicated on this table cannot be supplied.

* The parts listed below are for maintenance only, might differ from the parts used in the unit in appearances or dimensions.

Note: The symbols in the column "Remarks" indicate the following destinations.

U : North America model

N : Europe model

K : China model

B : Black model

SG : Silver gold model

MAIN PWB ASS'Y

Ref. No.	Part No.	Part Name	Remarks	Q'ty	New
SEMICONDUCTORS GROUP					
D281 283	nsp	1SS133T77 (TAPE)			
D301	nsp	1SS133T77 (TAPE)			
D391	nsp	1SS133T77 (TAPE)			
D501 503	nsp	1SS133T77 (TAPE)			
D504	nsp	1SS133T77 (TAPE)			
D601 607	nsp	1SS133T77 (TAPE)			
D608 615	nsp	1SS133T77 (TAPE)			
D616	nsp	1SS133T77 (TAPE)			
D811,812	nsp	1SS133T77 (TAPE)			
D813,814	00D2760761975	MTZJ18B T77			
D911,912	nsp	1SS133T77 (TAPE)			
D951 954	00MHD20027011	HSS81TD E 150V 150MA AXIAL TAPG.			
Q281	00D2690206908	KRC102M AT/P (10K 10K)			
Q283,284	00D2690206908	KRC102M AT/P (10K 10K)			
Q301,302	00MHT600121A1	KTA1268 PNP TRANSISTOR RANK=GR			
Q303 306	00MHT800931A1	KTC3200 NPN TRANSISTOR RANK=GR			
Q307,308	00MHT600121A1	KTA1268 PNP TRANSISTOR RANK=GR			
Q309	00D2690206908	KRC102M AT/P (10K 10K)			
Q313,314	00MHT600121A1	KTA1268 PNP TRANSISTOR RANK=GR			
Q315 318	00MHT800931A1	KTC3200 NPN TRANSISTOR RANK=GR			
Q319,320	00MHT600121A1	KTA1268 PNP TRANSISTOR RANK=GR			
Q381	00D2630609002	NJM2068DDC +T			
Q391	00MHC10309030	IC LC78212:CMOS LOGIC SANYO			
Q501,502	00MHT600121A1	KTA1268 PNP TRANSISTOR RANK=GR			
Q503 506	00MHT800931A1	KTC3200 NPN TRANSISTOR RANK=GR			
Q507,508	00MHT600121A1	KTA1268 PNP TRANSISTOR RANK=GR			
Q509,510	00MHT800931A1	KTC3200 NPN TRANSISTOR RANK=GR			
Q511 514	00MHT600121A1	KTA1268 PNP TRANSISTOR RANK=GR			
Q515,516	00MHT800931A1	KTC3200 NPN TRANSISTOR RANK=GR			
Q517,518	00MHT600121A1	KTA1268 PNP TRANSISTOR RANK=GR			
Q519,520	00MHT800931A1	KTC3200 NPN TRANSISTOR RANK=GR			
Q521,522	00MHT600121A1	KTA1268 PNP TRANSISTOR RANK=GR			
Q523 526	00MHT800931A1	KTC3200 NPN TRANSISTOR RANK=GR			
Q527,528	00MHT600121A1	KTA1268 PNP TRANSISTOR RANK=GR			
Q601,602	00MHT600121A1	KTA1268 PNP TRANSISTOR RANK=GR			
Q603,604	00MHT800931A1	KTC3200 NPN TRANSISTOR RANK=GR			
Q605,606	00MHT800931A1	KTC3200 NPN TRANSISTOR RANK=GR			
Q607,608	00MHT600121A1	KTA1268 PNP TRANSISTOR RANK=GR			
Q609,610	00MHT800931A1	KTC3200 NPN TRANSISTOR RANK=GR			
Q611 614	00MHT600121A1	KTA1268 PNP TRANSISTOR RANK=GR			
Q615,616	00MHT800931A1	KTC3200 NPN TRANSISTOR RANK=GR			
Q617,618	00MHT600121A1	KTA1268 PNP TRANSISTOR RANK=GR			
Q619,620	00MHT800931A1	KTC3200 NPN TRANSISTOR RANK=GR			
Q621Q622	00D2710168900	2SA1145 (O)/(Y)TPE6			
Q623,624	00D2730281919	2SC2705 (Y)TPE6			
Q625,626	00D2710311906	KTA1267 GR AT/P			
Q627 630	00D2730468907	KTC3199 GR AT/P			
Q631,632	00D2710311906	KTA1267 GR AT/P			
Q633,634	00D2730468907	KTC3199 GR AT/P			
Q635,636	00D2710311906	KTA1267 GR AT/P			
△ Q705,706	00D2730281919	2SC2705 (Y)TPE6			
△ Q707,708	00D2710168900	2SA1145 (O)/(Y)TPE6			
△ Q709	00MHT334232A0	TRANSISTOR 2SC3423 O OR Y			
△ Q710	00MHT334232A0	TRANSISTOR 2SC3423 O OR Y			
△ Q711	00MHT113602A0	TRANSISTOR 2SA1360 O OR Y			

	Ref. No.	Part No.	Part Name	Remarks	Q'ty	New
△	Q712	00MHT113602A0	TRANSISTOR 2SA1360 O OR Y			
	Q811	00D2710311906	KTA1267 GR AT/P			
	Q812	00D2730468907	KTC3199 GR AT/P			
△	Q813	00MHT41415100	TRANSISTOR 2SD1415			
△	Q814	00MHT21020100	2SB1020			
	Q815	00D2710311906	KTA1267 GR AT/P			
	Q901	00D2730468907	KTC3199 GR AT/P			
	Q902 904	00D2730468907	KTC3199 GR AT/P			
	Q911,918	00D2710311906	KTA1267 GR AT/P			
	Q912	00D2690206908	KRC102M AT/P (10K 10K)			
	Q913	00D2690204900	KRA102M AT/P (10K 10K)			
	Q914 916	00D2690206908	KRC102M AT/P (10K 10K)			
	Q917	00D2730468907	KTC3199 GR AT/P			
	Q951,952	00MHT800931A1	KTC3200 NPN TRANSISTOR RANK=GR			
	Q953,954	00MHT600121A1	KTA1268 PNP TRANSISTOR RANK=GR			
	Q955,956	00D2730468907	KTC3199 GR AT/P			
	Q957	00D2690206908	KRC102M AT/P (10K 10K)			
	Q958	00D2730468907	KTC3199 GR AT/P			
CAPACITORS GROUP						
	C301	00MDD38104011	50V DC 0.1UF +80 20%			
	C305,306	00MOA106035Z1	ROS 35V 100M F3#PE T2 (10UF 35V)			
	C307,308	00MOF55331581	330PF 100V + 5% FNS			
	C309,310	00MOA226025Z1	ROS 25V 220M F3#PE T2 (22UF 25V)			
	C311,312	00MOA227025R1	ROA 25V 221M H5#PE T2 (220UF 25V)			
	C331,332	00MDD38104011	50V DC 0.1UF +80 20%			
	C337,338	00MDD38104011	50V DC 0.1UF +80 20%			
	C343,344	00MDD38104011	50V DC 0.1UF +80 20%			
	C351,352	00MOA106035Z1	ROS 35V 100M F3#PE T2 (10UF 35V)			
	C353,354	00MOF55331581	330PF 100V + 5% FNS			
	C355,356	00MOA226025Z1	ROS 25V 220M F3#PE T2 (22UF 25V)			
	C357,358	00MOA227025R1	ROA 25V 221M H5#PE T2 (220UF 25V)			
	C381,382	00MOA106035Z1	ROS 35V 100M F3#PE T2 (10UF 35V)			
	C383,384	00MOA10605021	10 UF M 50V RA 2			
	C385,386	00MOA227025Z1	220 UF M 25V RA 2			
	C393	00MOA10605021	10 UF M 50V RA 2			
	C501,502	00MOA226025Z1	ROS 25V 220M F3#PE T2 (22UF 25V)			
	C503,504	00MOF55101591	100PF 200V + 5% FAS			
	C505 508	00MOA227025R1	ROA 25V 221M H5#PE T2 (220UF 25V)			
	C509,510	00MOF55101591	100PF 200V + 5% FAS			
	C511,512	00MOA226025Z1	ROS 25V 220M F3#PE T2 (22UF 25V)			
	C601,602	00MOA226025Z1	ROS 25V 220M F3#PE T2 (22UF 25V)			
	C603 606	00MOA22706326	220 UF M 63V RA 2			
	C607,608	00MOF55681581	680PF 100V + 5% FNS			
	C609,610	00MOA227025Z1	220 UF M 25V RA 2			
	C611,612	00MOF55101591	100PF 200V + 5% FAS	N,K		
	C613 616	00MOA226025Z1	ROS 25V 220M F3#PE T2 (22UF 25V)			
	C701,702	00MOA226025Z1	ROS 25V 220M F3#PE T2 (22UF 25V)			
	C705,706	00MOF55103581	0.01UF 100V + 5% FNS			
	C707,708	00MOF55393586	0.039UF 100V + 5% FAS			
△	C801,802	1340500210040	LKG1J183MESCZT			
	C811,812	00MOA106035Z1	ROS 35V 100M F3#PE T2 (10UF 35V)			
	C813 816	00MOA227025R1	ROA 25V 221M H5#PE T2 (220UF 25V)			
	C821	00MOA227035Z1	220UF 35V M RA 2			
	C901	00D2544573949	CE04W1H010MT(RA3)			
	C902	00MOA10605021	10 UF M 50V RA 2			
	C903	00MDD38104011	50V DC 0.1UF +80 20%			
	C911 916	00MDD38104011	50V DC 0.1UF +80 20%			
	C951,952	00D2544573936	CE04W1HR47MT(RA3)			
	C953	00MOA476025Z1	47 UF M 25V RA 2			
	C954	00MOA10605021	10 UF M 50V RA 2			
RESISTORS GROUP						
	R281	00MGG05100160	10 OHM + 5% 1/6W FLAMERETARDANT			
	R283,284	00MGG05100160	10 OHM + 5% 1/6W FLAMERETARDANT			
	R323 325	00MGG05100160	10 OHM + 5% 1/6W FLAMERETARDANT			
	R371,372	00MGG05100160	10 OHM + 5% 1/6W FLAMERETARDANT			

Ref. No.	Part No.	Part Name	Remarks	Q'ty	New
R387,388	00MGG05100160	10 OHM + 5% 1/6W FLAMERETARDANT			
R553 556	00MGG05100160	10 OHM + 5% 1/6W FLAMERETARDANT			
R619 622	00MGG05471160	470 OHM + 5% 1/6W FLAMERETARDANT			
R623 626	00MGG05151160	150 OHM + 5% 1/6W FLAMERETARDANT			
△ R659 R662	1210500024030	CFP1/4CGTA100J FLAMERETARDANT			
R713 716	00MGG05471160	470 OHM + 5% 1/6W FLAMERETARDANT			
R717,718	00MGG05102160	1K OHM + 5% 1/6W FLAMERETARDANT			
R719 722	00MGG05470160	47 OHM + 5% 1/6W FLAMERETARDANT			
R723,724	1210500034060	CFP1/4CGTA221J FLAMERETARDANT			
R725 728	00MGG05100160	10 OHM + 5% 1/6W FLAMERETARDANT			
△ R729 732	00MGO05001056	0.1 OHMS + 5% 5W PBR58			
R733,734	1240500010030	MOS2CL15A100J10OHM + 5% 2W			
△ R819,820	00MGG05047160	4.7 OHM + 5% 1/6W FLAMERETARDANT			
R821	00MGG05220160	22 OHM + 5% 1/6W FLAMERETARDANT			
R822	00MGG05100160	10 OHM + 5% 1/6W FLAMERETARDANT			
R951 954	00MGG05471160	470 OHM + 5% 1/6W FLAMERETARDANT			
R955,956	00MGG05472160	4.7K OHM + 5% 1/6W FLAMERETARDANT			
OTHER PARTS GROUP					
J281	nsp	B5B EH TS (LF)(SN) 5P RADIAL TAPING			
J282	nsp	B3B EH TS (LF)(SN) 3P RADIAL TAPING			
J283	nsp	B6B EH TS (LF)(SN) 6P RADIAL TAPING JST			
J301	643810029001S	RCA PIN JACK 2P AU MSP 242V3 12 GILT LF			
J302 304	643810028008S	RCA PIN JACK 4P AU MSP 244V4 17 GILT LF			
J331	nsp	B5B EH TS (LF)(SN) 5P RADIAL TAPING			
J501	nsp	B07P MQ C			
J701,702	nsp	B5B EH TS (LF)(SN) 5P RADIAL TAPING			
J703 706	nsp	IMSA 6065B 06Z065 PT1			
J707,708	nsp	S2B EH			
J709	nsp	4P PLUG B4P VH			
J801	nsp	JST 3P PLUG B3P VH P=3.96M/M			
J811	nsp	B3B EH TS (LF)(SN) 3P RADIAL TAPING			
J821	nsp	GND TERMINAL FOR PCB			
J901	nsp	B13B PH K S (LF)(SN)			
J911	nsp	B4B EH TS (LF)(SN) 4P RADIAL TAPING			
J912	nsp	GND TERMINAL FOR PCB			
J913	nsp	M3 SCREW TERMINAL			
OTHERS PARTS GROUP					
CD01 03	00MOA10605021	10 UF M 50V RA 2			
CD06	00MOA10605021	10 UF M 50V RA 2			
CD07 09	00MOA10605021	10 UF M 50V RA 2			
CD12,13	00MOA10605021	10 UF M 50V RA 2			
CD15	133050074500S	CQ93M2E101J(LP)			
DD01	nsp	1SS133T77 (TAPE)			
DD03,04	nsp	1SS133T77 (TAPE)			
DD05 07	nsp	1SS133T77 (TAPE)			
△ G801	00MBF68400016	! 0.68UF/4.7OHM			
H801	nsp	HEAT SINK			
H802	nsp	HEAT SINK			
H803	nsp	SCREW			
H804	nsp	SCREW			
JD01	nsp	B5B EH TS (LF)(SN) 5P RADIAL TAPING			
L281 284	00D2140208003	RELAY(NA24W K)			
L301	00D2140208003	RELAY(NA24W K)			
L912	nsp	BL02RN2 R62T2 FERRITE BEAD			
QD01,02	00D2630609002	NJM2068DDC +T			
QD03	00D2690206908	KRC102M AT/P (10K 10K)			
QD04	00D2730468907	KTC3199 GR AT/P			
W601,602	nsp	EHR SCN 2.5MMPICH DIP TYPE 5PIN 8CM			

	Ref. No.	Part No.	Part Name	Remarks	Q'ty	New
	W801	nsp	SIN SRA 1P 140MM			
	W951	nsp	EHR SCN 2.5MMPICH DIP TYPE 4PIN 10CM			
	WD01	nsp	EHR SCN 2.5MMPICH DIP TYPE 5PIN 14CM			

FRONT PWB ASS'Y

Ref. No.	Part No.	Part Name	Remarks	Q'ty	New
SEMICONDUCTORS GROUP					
D0101	nsp	1SS133T77 (TAPE)			
D0103	00MHD20002711	1A3 1A/200V			
D0191	00D3939607908	SLR342VC(TB7)			
D0240 0245	263710014404S	SELT2E10C S TP6 F/G RANK			
D0246	176010004401S	SELU2610C S TP6			
D0247 0250	176010009406S	SELK2E14C D BLUE LED			*
⚠ D0851	00MHD20002711	1A3 1A/200V			
D0852	00D2760761975	MTZJ18B T77			
⚠ D0853 0856	00MHD20055101	ISHOTTKY 11EQS10 1A 100V			
⚠ D0857 0861	00MHD20002711	1A3 1A/200V			
D0862	nsp	1SS133T77 (TAPE)			
⚠ D0863 0868	00MHD20002711	1A3 1A/200V			
U0101	2439100016008	TMP86FH47UG			
U0102	235010049402S	KIA7042AP AT/P 4.2V RESET IC			*
U0103	00MHC1043399Z	AT24C08BN SH T			
U0201 0204	00D2630896909	NJM2068MD TE1 +C			
U0270	00MHW10004210	RPM6936 V4 (IR SENSOR)			
⚠ U0851	00D2622977933	BA50BC0FP E2			
Q0101,0102	00D2690184907	KRA102S RTK/P (10K 10K)			
Q0103,0104	00D2730468907	KTC3199 GR AT/P			
Q0105 0108	00D2690184907	KRA102S RTK/P (10K 10K)			
Q0109	00D2730468907	KTC3199 GR AT/P			
Q0110 0113	00D2690184907	KRA102S RTK/P (10K 10K)			
Q0114	00D2690192902	KRC102S RTK/P (10K 10K)			
Q0115	00D2710311906	KTA1267 GR AT/P			
Q0116	00D2690192902	KRC102S RTK/P (10K 10K)			
Q0117	00MHT600141B1	KTA1271 PNP TRANSISTOR RANK=Y			
Q0118	00MHT800951B1	KTC3203 NPN TRANSISTOR RANK=Y			
Q0119	00D2710311906	KTA1267 GR AT/P			
Q0120	00MHT600141B1	KTA1271 PNP TRANSISTOR RANK=Y			
Q0121	00MHT800951B1	KTC3203 NPN TRANSISTOR RANK=Y			
Q0122	00D2690192902	KRC102S RTK/P (10K 10K)			
Q0201 0204	00D2690206908	KRC102M AT/P (10K 10K)			
Q0851	00D2690206908	KRC102M AT/P (10K 10K)			
Q0852	00D2730468907	KTC3199 GR AT/P			
Q0853	00D2690204900	KRA102M AT/P (10K 10K)			
Q0854	00D2710311906	KTA1267 GR AT/P			
RESISTORS GROUP					
R0137	00MGG05022160	2.2 OHM + 5% 1/6W FLAMERETARDANT			
R0225,0226	00MGG05100160	10 OHM + 5% 1/6W FLAMERETARDANT			
R0791,0792	00MGG05100160	10 OHM + 5% 1/6W FLAMERETARDANT			
R0851	00MGG05220160	22 OHM + 5% 1/6W FLAMERETARDANT			
⚠ R0853	00MBF68400016	! 0.68UF/4.7OHM			
⚠ R0855,0856	00MGG05010120	ERD50FJ1R0P or SPRX1CM12.5A J 1R0 FLAMERETARDANT			
V0201 0203	0750100020070	4K14K124003J			
V0204	0750100030000	RK14K1240D0P			
CAPACITORS GROUP					
C0101,0102	nsp	CK73F1E104ZT +1608			
C0103	00MEJ10602511	10UF/ 25V			
C0104	nsp	CK73F1E104ZT +1608			
C0105	00MEJ10602511	10UF/ 25V			
C0106 0108	nsp	CK73F1E104ZT +1608			
C0109	00D2544302974	CE04W1A101MT(SRE)			
C0110 0113	nsp	CK73F1E104ZT +1608			
C0116,0117	nsp	CK73F1E104ZT +1608			
C0118	00D2544573949	CE04W1H010MT(RA3)			

NOTE :
 When update Firmware, please confirm a last version in SDI.
 Use the service board after updating it.

Ref. No.	Part No.	Part Name	Remarks	Q'ty	New
C0119	nsp	CK73F1E104ZT +1608			
C0120	00D2544573949	CE04W1H010MT(RA3)			
C0121	nsp	CK73B1H103KT (1608) +1608			
C0181,0182	nsp	CK73B1H103KT (1608) +1608			
C0201,0202	00MOA22605021	22 UF M 50V RA 2			
C0203 0206	133050074500S	CQ93M2E101J(LP)			
C0207,0208	00MOA22605021	22 UF M 50V RA 2			
C0209,0210	00MOA10702521	100 UF M 25V RA 2			
C0211,0212	133050089595S	CQ93P2A103JT(PPF)	N,K		*
C0211,0212	133050089595S	CQ93P2A103JT(PPF)	U	2	*
C0213,0214	133050086503S	CQ93M2A221JT(PEF)			*
C0215,0216	00D2561059938	CF93A1H334JT (JL)			
C0217,0218	133050089526S	CQ93P2A102JT(PPF)			*
C0219,0220	00MEJ22505011	2.2UF/ 50V			
C0221,0222	133050090540S	CQ93P2A683JT(PPF)			
C0240 0245	nsp	CK73B1H103KT (1608) +1608			
C0247 0250	nsp	CK73B1H103KT (1608) +1608			
C0251,0252	00MEJ10602511	10UF/ 25V			
C0270,0271	nsp	CK73B1H103KT (1608) +1608			
C0272	00D2544302974	CE04W1A101MT(SRE)			
C0791,0792	133050089595S	CQ93P2A103JT(PPF)			
C0851	133050076599S	CQ93M2E103J(LP)			
△ C0852	133750061200S	#PHE840MA5100MA01R05			
C0853	00D2544573949	CE04W1H010MT(RA3)			
C0854,0855	00MOC47803546	4700UF/35V NICHICON PB FREE			
C0856	00MOA10605021	10 UF M 50V RA 2			
C0857	00D2544576700	CE04W1V222MC(RA3)			
C0859	00MOA10605021	10 UF M 50V RA 2			
C0860	00MOA22703521	220UF 35V M RA 2			
C0861	00MOA10605021	10 UF M 50V RA 2			
C0862	00D2544573949	CE04W1H010MT(RA3)			
C0863 0865	nsp	CK73F1E104ZT +1608			
C0866 0869	nsp	CK73B1H103KT (1608) +1608			
△ C0891	00D2538029713	CK45F2EAC471KC(KX)			
OTHERS PARTS GROUP					
△ F8520	0520100150000	02183.15MXP	N,K		
△ F8520	0520100180090	021806.3MXP (FUSE 6.3A 250V)	U	1	
H0251	nsp	BUFFER IR PM7003 24AJ			
H8521,8522	nsp	FUSE CLIP(TAPE)			
L0101,0102	nsp	BL02RN2 R62T2 FERRITE BEAD			
L0851 0853	nsp	BL02RN2 R62T2 FERRITE BEAD			
N0025	nsp	CONNECTOR 2P B3P VH			
N0026	nsp	2P PLUG B2P3S VH			
N0027	nsp	CONNECTOR 2P B3P VH			
N0029	nsp	CONNECTOR 2P B3P VH			
N0031	nsp	EHR SCN 2.5MMPICH DIP TYPE 3PIN 10CM			
N0032	nsp	S3B EH			
N0033	nsp	EHR SCN 3PIN 21CM			
N0036	nsp	S3B EH			
N0038	nsp	B3B EH TS (LF)(SN) 3P RADIAL TAPING			
N0039	nsp	JST 3P PLUG B3P VH P=3.96M/M			
N0041	nsp	EHR SCN 2.5MMPICH DIP TYPE 4PIN 10CM			
N0042	nsp	S4B EH			
N0043	nsp	B4B EH TS (LF)(SN) 4P RADIAL TAPING			
N0055	nsp	EHR SCN 5PIN 17CM			
N0059	nsp	05FMN SSTK A FFC CONNECTOR			
N0061	nsp	B6B EH TS (LF)(SN) 6P RADIAL TAPING JST			
N0064	nsp	EHR SCN 6PIN 14CM			
N0101,0102	nsp	B10B PH K S (LF)(SN)			
N0121	nsp	B13B PH K S (LF)(SN)			
N0122	nsp	B12B PH K S (LF)(SN)			
N0124	nsp	B12B PH K S (LF)(SN)			

	Ref. No.	Part No.	Part Name	Remarks	Q'ty	New
	N0304	nsp	EHR SCN 3P 150MM(SHIELD WIRE)			
	S0181	0630100020040	SRRSIC			
	S0270 0273	00D2125611903	TACT SWITCH(TAPE H5)			
⚠	S0851	682010022003S	RELAY(DLS9D1 O_M)TV 8			*
⚠	S0891	665010008002D	POWER SWITCH (TV 5)			
	K0791	6430100050030	YKB26 5009G HP JACK(SILVER)			
	K0852	00MYT02020890	YKC21 3046V 2P RCA PIN JACK			
	B0202	nsp	SIN SRA 1PIN 16CM			
	B0791	nsp	SIN SRA 1PIN 11CM			
	B0851	nsp	GND TERMINAL FOR PCB			
	X0101	00MFQ08004061	CSTS MG 8MHZ TAPING(15PF)			
⚠	T0851	101710067005M	# STANDBY TRANS FOR 230V	N,K		
⚠	T0851	101710068008M	# STANDBY TRANS FOR 120V	U		
⚠	U0852	00D2630809006	NJM7805FA(S)			
	Z0852	nsp	HEAT SINK			
	Z0853	nsp	SCREW			
	0011K	nsp	T6.3AL 250V	U		

AMP PWB ASS'Y

Ref. No.	Part No.	Part Name	Remarks	Q'ty	New
SEMICONDUCTORS GROUP					
D401,408	nsp	1SS133T77 (TAPE)			
D409,416	nsp	1SS133T77 (TAPE)			
D751	nsp	1SS133T77 (TAPE)			
Q401,402	00MHT600121A1	KTA1268 PNP TRANSISTOR RANK=GR			
Q403,406	00MHT800931A1	KTC3200 NPN TRANSISTOR RANK=GR			
Q407,408	00MHT600121A1	KTA1268 PNP TRANSISTOR RANK=GR			
Q409,410	00MHT800931A1	KTC3200 NPN TRANSISTOR RANK=GR			
Q411,414	00MHT600121A1	KTA1268 PNP TRANSISTOR RANK=GR			
Q415,416	00MHT800931A1	KTC3200 NPN TRANSISTOR RANK=GR			
Q417,418	00MHT600121A1	KTA1268 PNP TRANSISTOR RANK=GR			
Q419,420	00MHT800931A1	KTC3200 NPN TRANSISTOR RANK=GR			
Q421,422	00MHT600121A1	KTA1268 PNP TRANSISTOR RANK=GR			
Q423,426	00MHT800931A1	KTC3200 NPN TRANSISTOR RANK=GR			
Q427,428	00MHT600121A1	KTA1268 PNP TRANSISTOR RANK=GR			
Q429,430	00D2730468907	KTC3199 GR AT/P			
Q431,432	00D2710311906	KTA1267 GR AT/P			
Q433,434	00D2730468907	KTC3199 GR AT/P			
Q435,438	00D2710311906	KTA1267 GR AT/P			
Q439,440	00D2730468907	KTC3199 GR AT/P			
Q441,442	00MHT600121A1	KTA1268 PNP TRANSISTOR RANK=GR			
Q443,444	00MHT800931A1	KTC3200 NPN TRANSISTOR RANK=GR			
RESISTORS GROUP					
R467,470	00MGG05100160	10 OHM + 5% 1/6W FLAMERETARDANT			
R591	0750100040030	RK27112MC			
R753,755	00MGG05220160	22 OHM + 5% 1/6W FLAMERETARDANT			
CAPACITORS GROUP					
C297,298	00MOF55331581	330PF 100V + 5% FNS			
C299,300	00MDD38104011	50V DC 0.1UF +80 20%			
C401	00MDD38104011	50V DC 0.1UF +80 20%			
C403,404	133050074548S	CQ93M2E221J(LP)	N,K		
C405,406	00MOA106035Z1	ROS 35V 100M F3#PE T2 (10UF 35V)			
C407,408	00MOF55101591	100PF 200V + 5% FAS			
C409,410	133050075510S	CQ93M2E821J(LP)			*
C411,412	133050076537S	CQ93M2E332J(LP)			*
C413,414	00MOF55102581	1000PF 100V FNS			
C415,416	00MOF55103581	0.01UF 100V + 5% FNS			
C417,418	00MOF55393586	0.039UF 100V + 5% FAS			
C419,420	00MOA22801626	2200UF 16V			
C421,422	00MOA106035Z1	ROS 35V 100M F3#PE T2 (10UF 35V)			
C425,428	00MOA227025R1	ROA 25V 221M H5#PE T2 (220UF 25V)			
C591,592	00D2544573949	CE04W1H010MT(RA3)			
C751,752	00MOF55103581	0.01UF 100V + 5% FNS	N,K		
C753,754	00MOA10605021	10 UF M 50V RA 2			
OTHERS PARTS GROUP					
J011,018	nsp	SPK CONTACTOR			
J291	643810028008S	RCA PIN JACK 4P AU MSP 244V4 17 GILT LF			
J401	643810029001S	RCA PIN JACK 2P AU MSP 242V3 12 GILT LF			
J591	nsp	B3B EH TS (LF)(SN) 3P RADIAL TAPING			
J592	nsp	07MQ ST L			
J593	nsp	RETAINER			
J751	nsp	4P PLUG B4P VH			
J754	nsp	B3B EH TS (LF)(SN) 3P RADIAL TAPING			
J755	nsp	B4B EH TS (LF)(SN) 4P RADIAL TAPING			
J756,758	nsp	STYLE PIN			
L401,402	nsp	320 MH CHOKE COIL (TOROIDAL)	N,K		
L751,752	00D2140213001	RELAY(FTR F4)			
L753	00D2140208003	RELAY(NA24W K)			
W291	nsp	EHR SCN 2.5MMPICH DIP TYPE 6PIN 8CM			
W401	nsp	EHR SCN 2.5MMPICH DIP TYPE 5PIN 8CM			